

A	B	C (mm)		D
1	S322-418/A	1520	660	1/2
2	S322-325	660	200	1/2

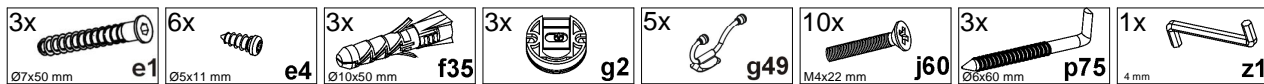

1 §2

2 §6

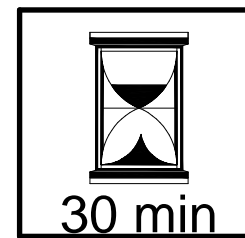
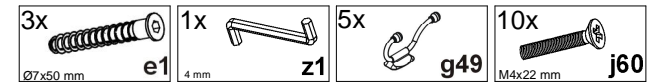
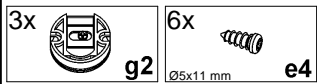
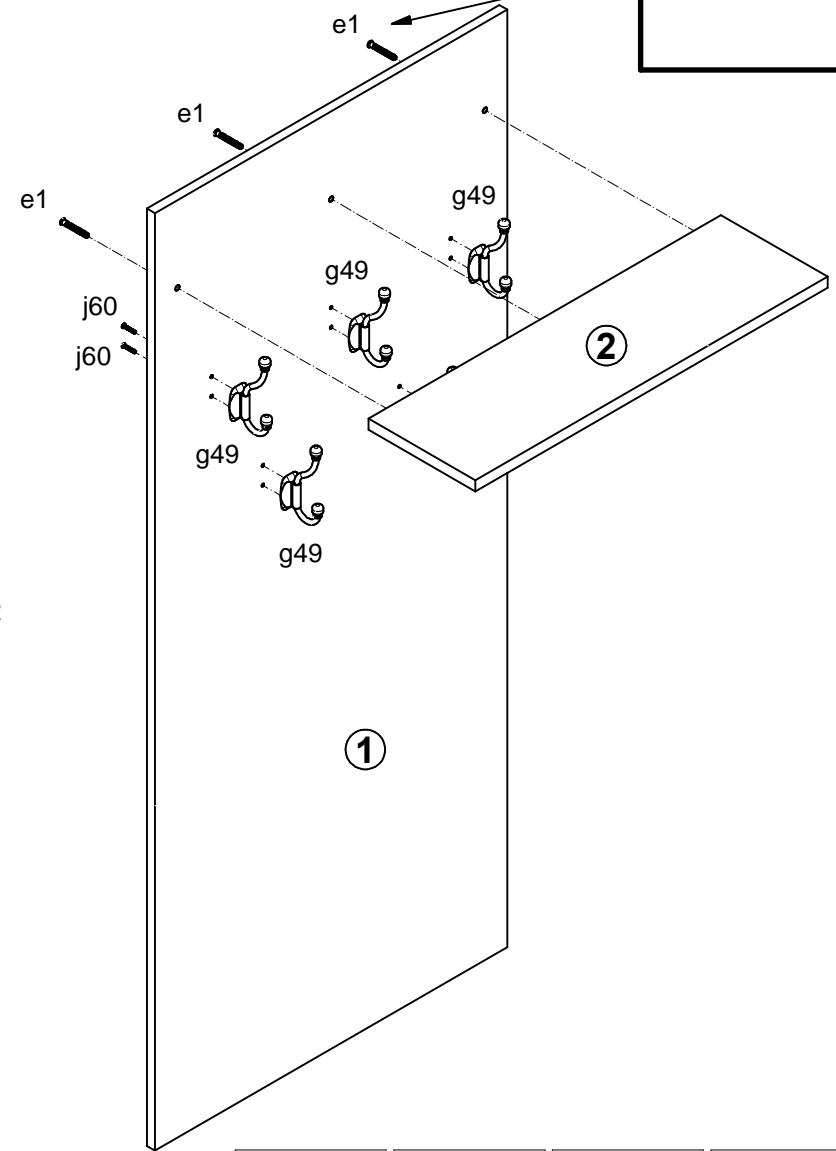
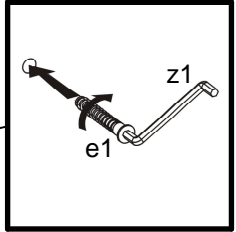
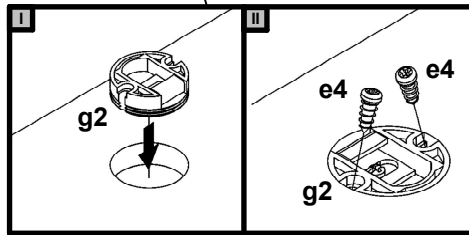
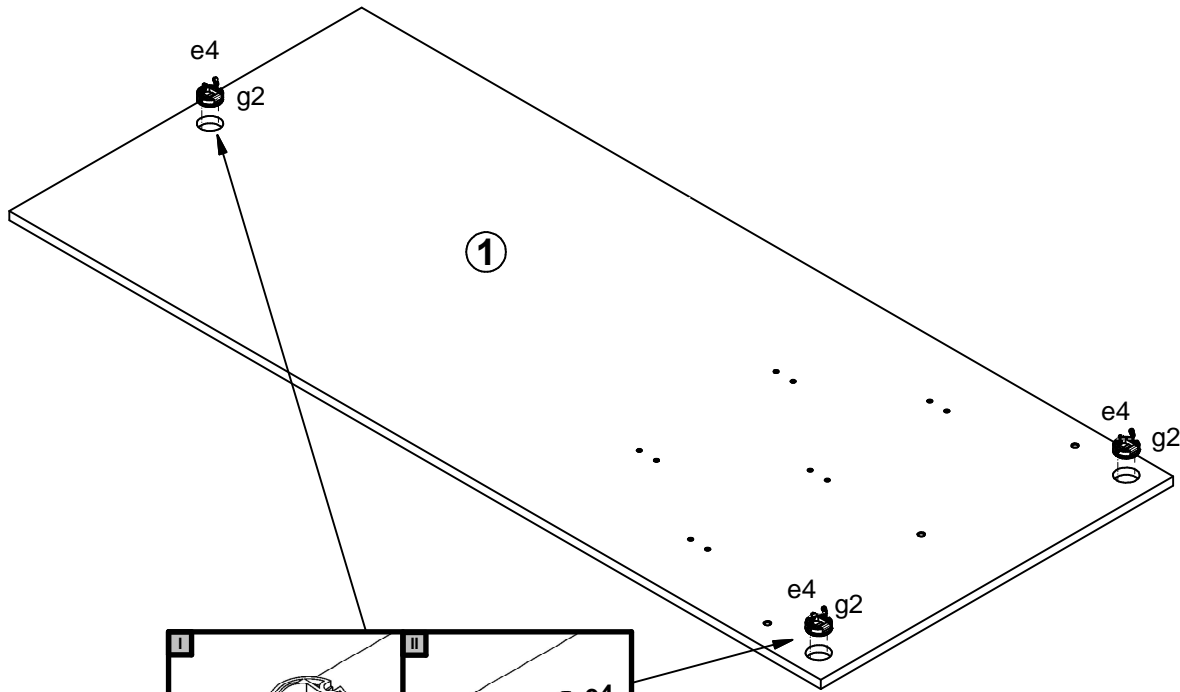

3

