

**A**

# NANDU

**S441-SZFN2D**

A	B	C	D	
1	S441-0016	1928	306	4/4
2	S441-0017	1928	456	4/4
3	S441-1030	2000	375	2/4
4	S441-1031	2000	375	2/4
5	S441-1032	1909	300	3/4
6	S441-1033	1909	300	3/4
7	S441-1034	1909	355	2/4
8	S441-3019	895	895	1/4
9	S441-3020	915	915	1/4
10	S441-3021	320	298	1/4
11	S441-3022	319	298	1/4
12	S441-4017	768	60	2/4
13	S441-9305	1929	899	2/4
14	S441-9306	1929	577	3/4
15	dr-540	540	22	1/4

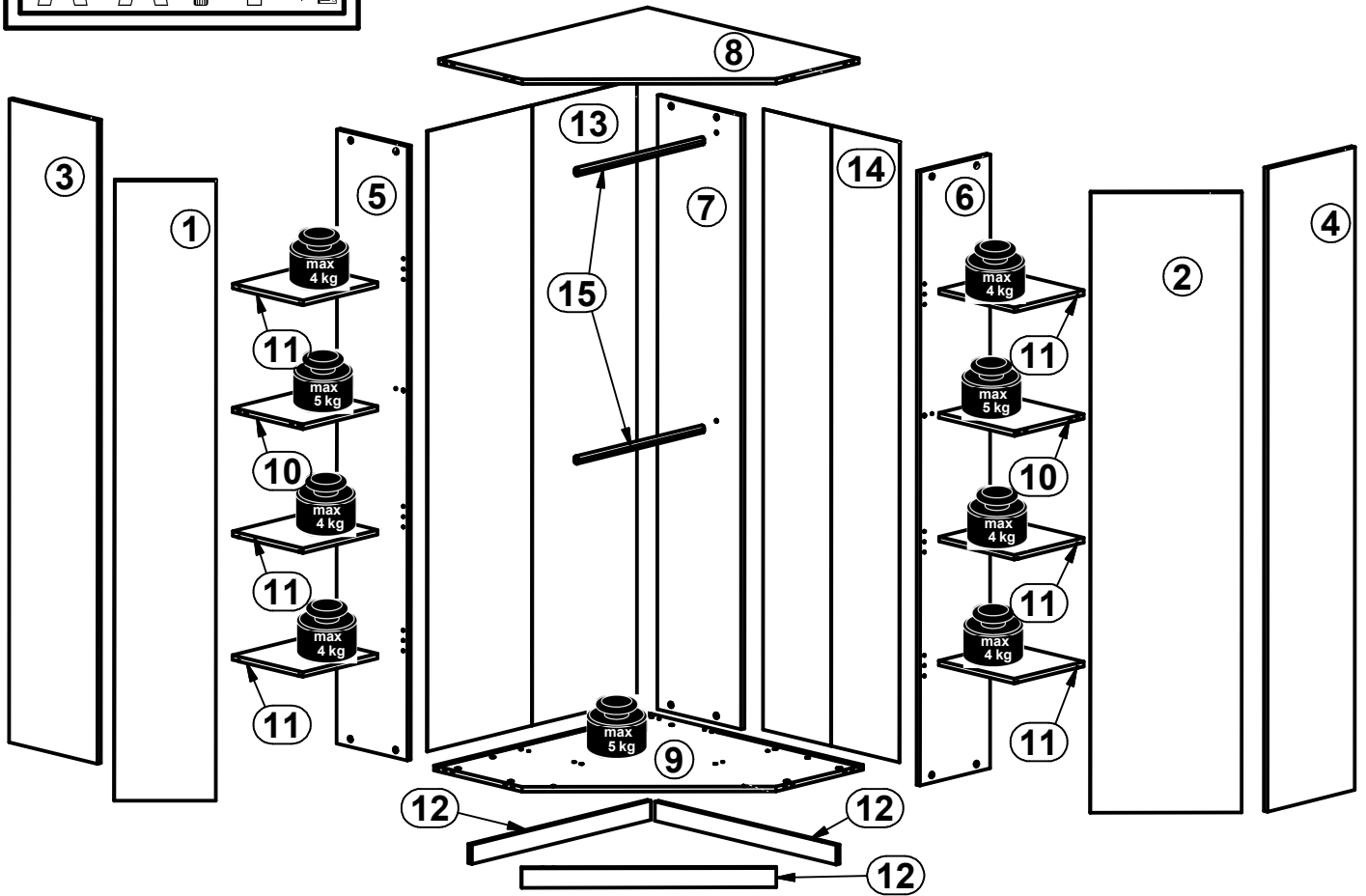
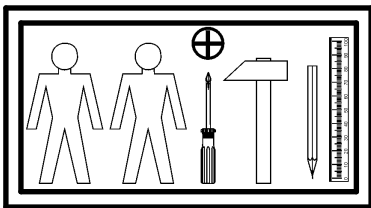
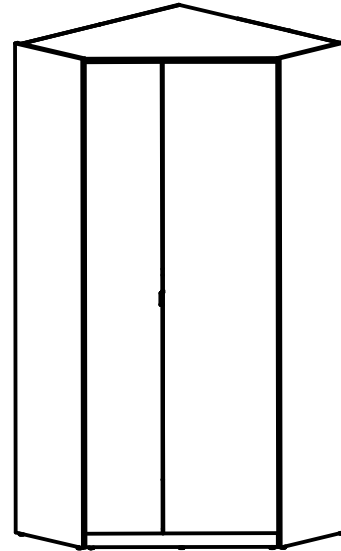

6x a10	2x a133	6x H0 b84	1x 32 mm c478	24x Ø5x17 mm d1	6x Ø7x50 mm e1	34x Ø8x30 mm f1	13x k1	70x 1.4x20 mm l1
14x l2	4x h=22mm n1	4x Ø3.5x13 mm p1	2x Ø3.5x14 mm p133	11x Ø3.5x16 mm p38	12x Ø3.5x15 mm p51	28x Ø15x12 mm #16 r1	28x 20/11 r42	6x Ø14x0.5 mm s59
20x Ø 20mm s68	1x 4 mm z1	1x n26	2x silikon o21					

# 1

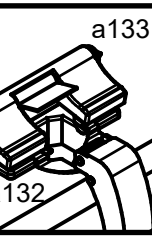
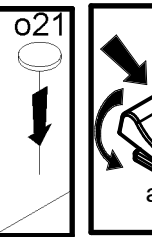
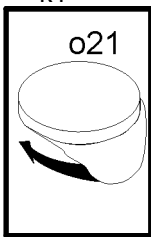
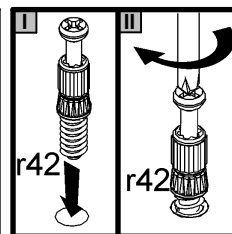
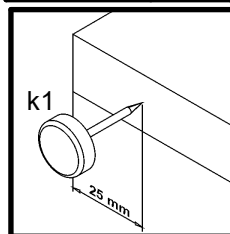
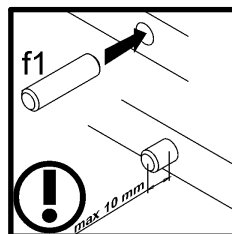
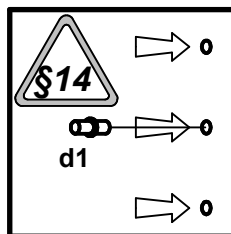
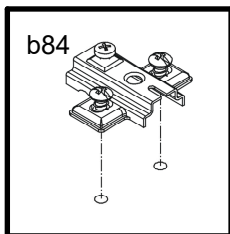
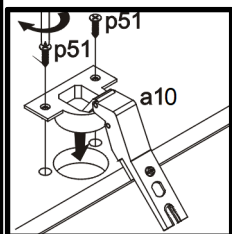
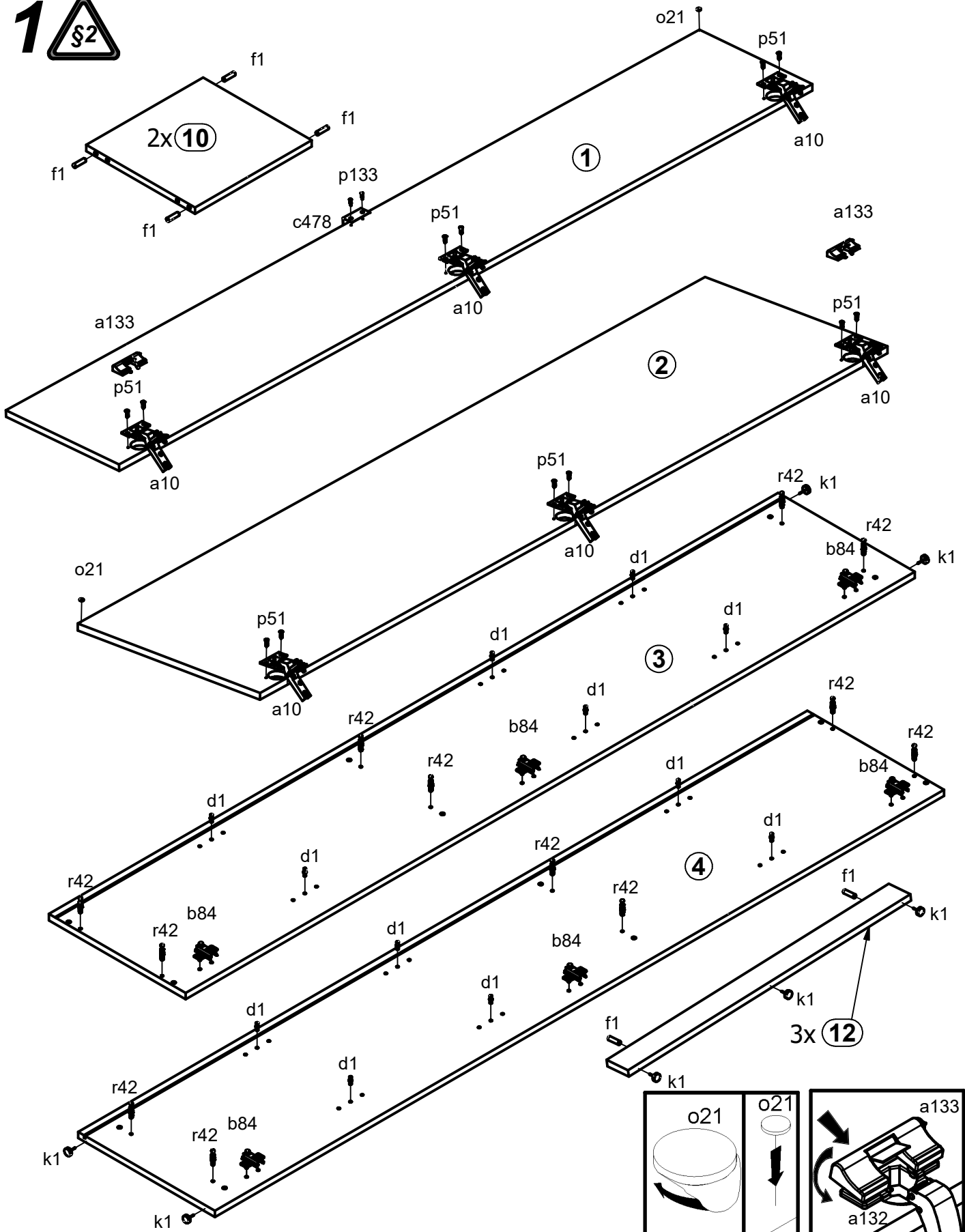

# 2

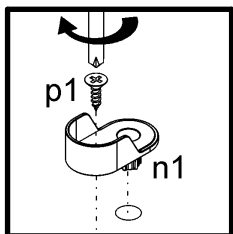
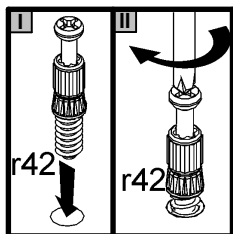
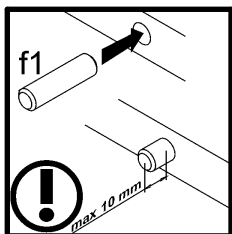
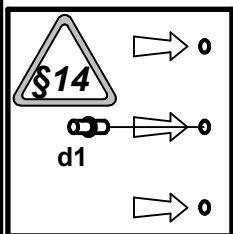
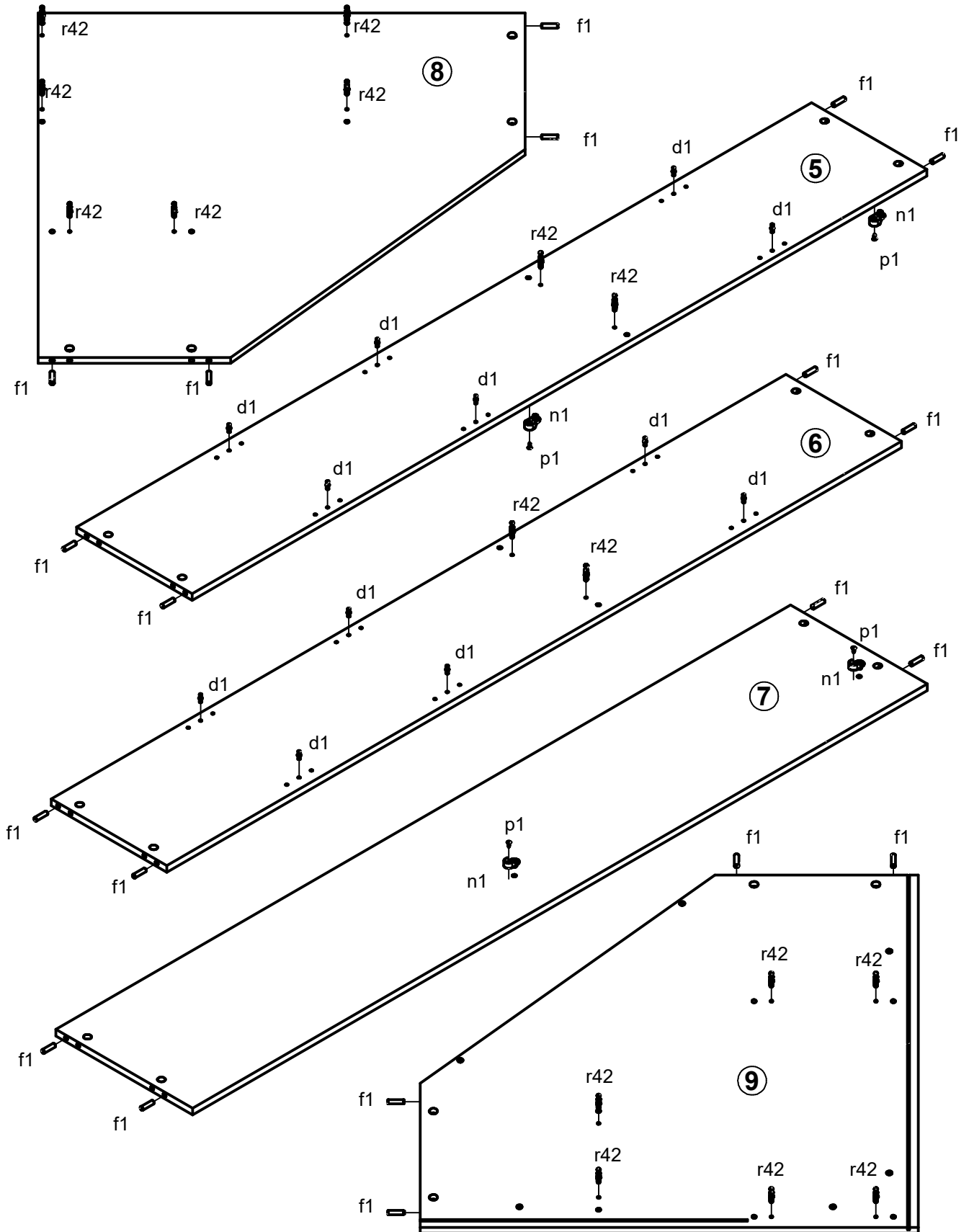

# 3

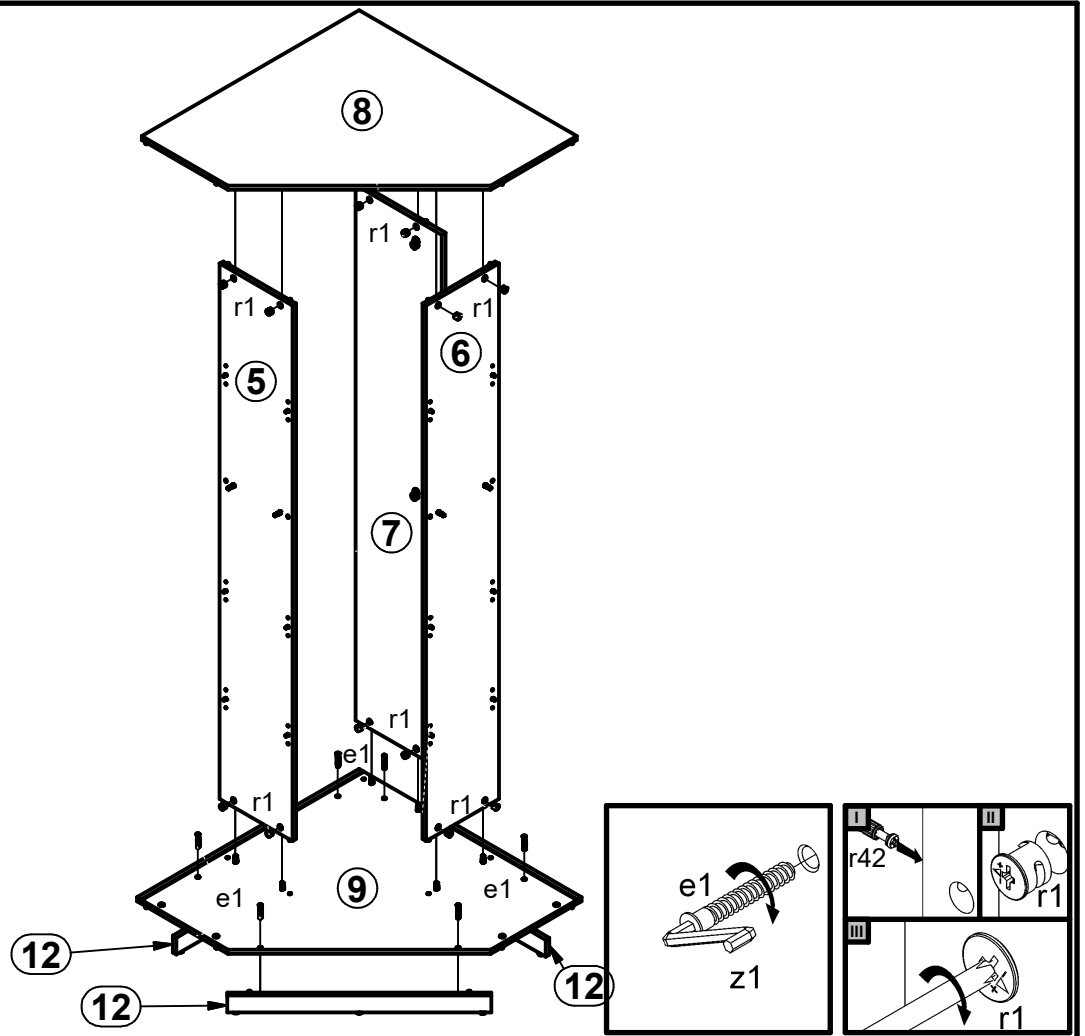

# 4

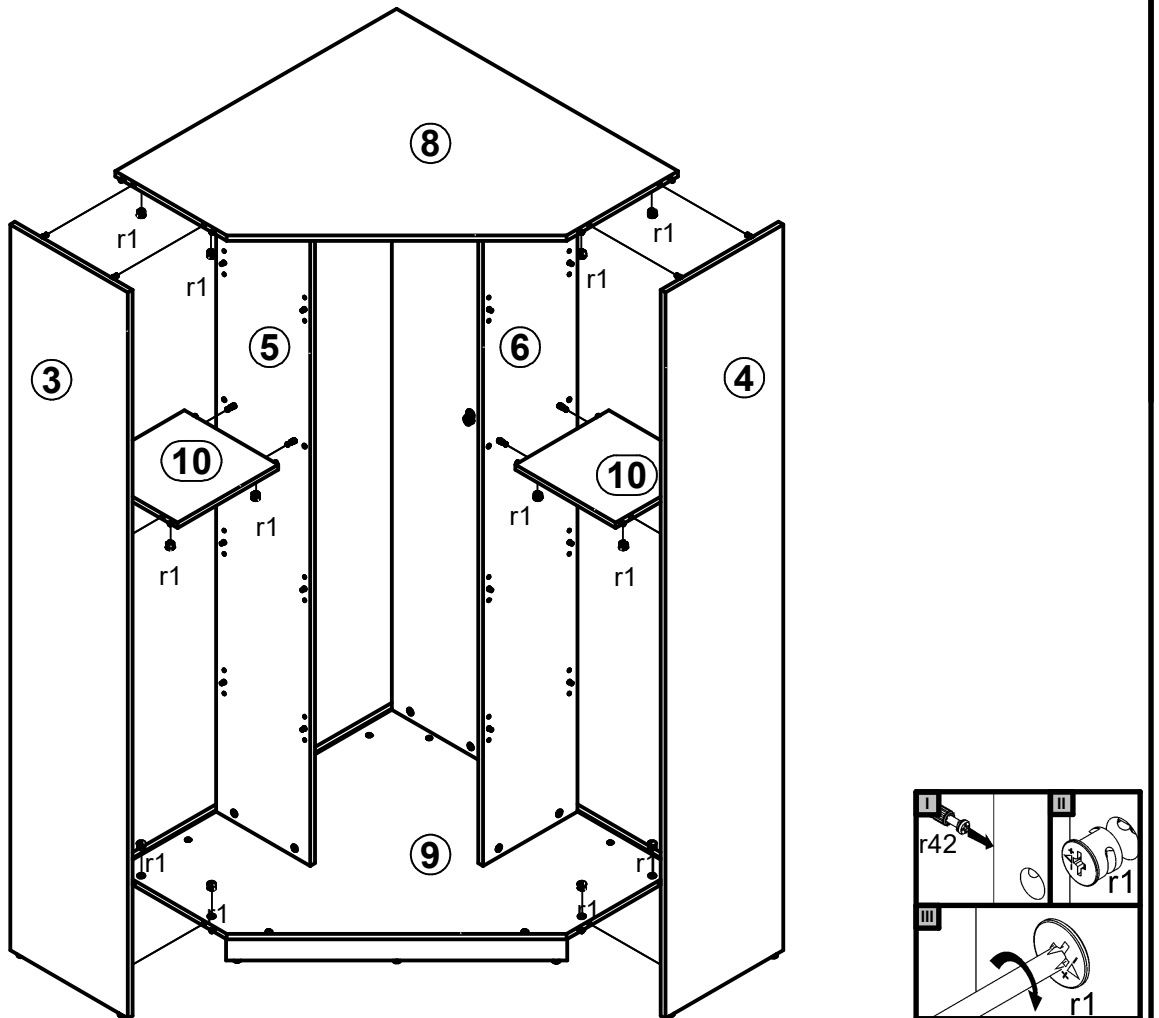

# 5

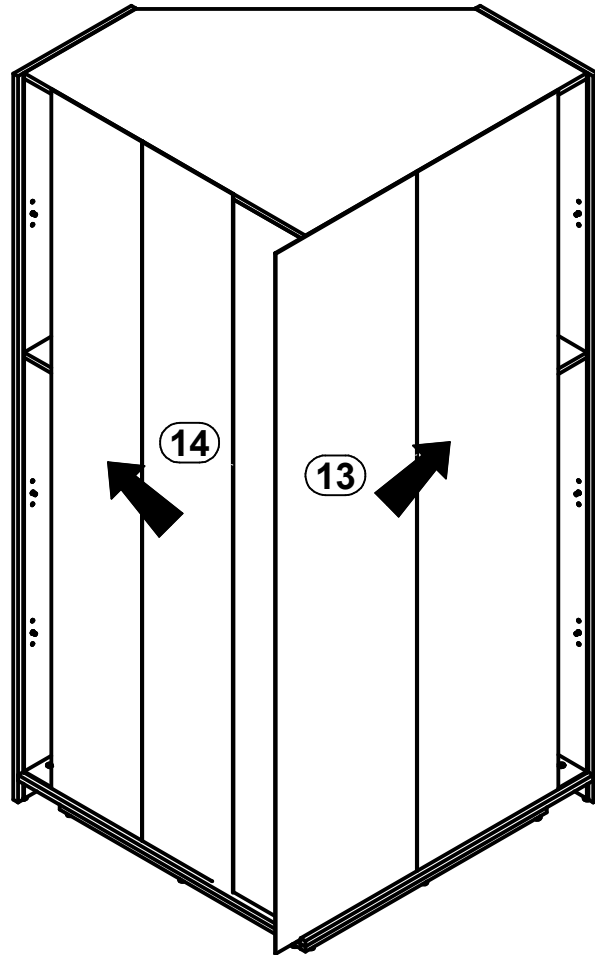

# 6

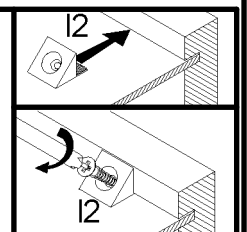
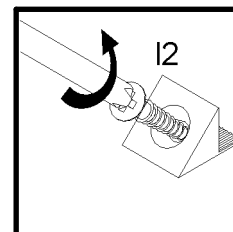
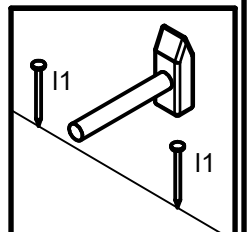
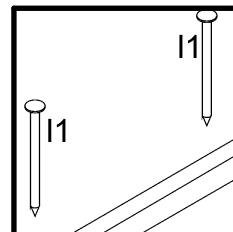
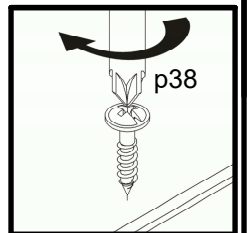
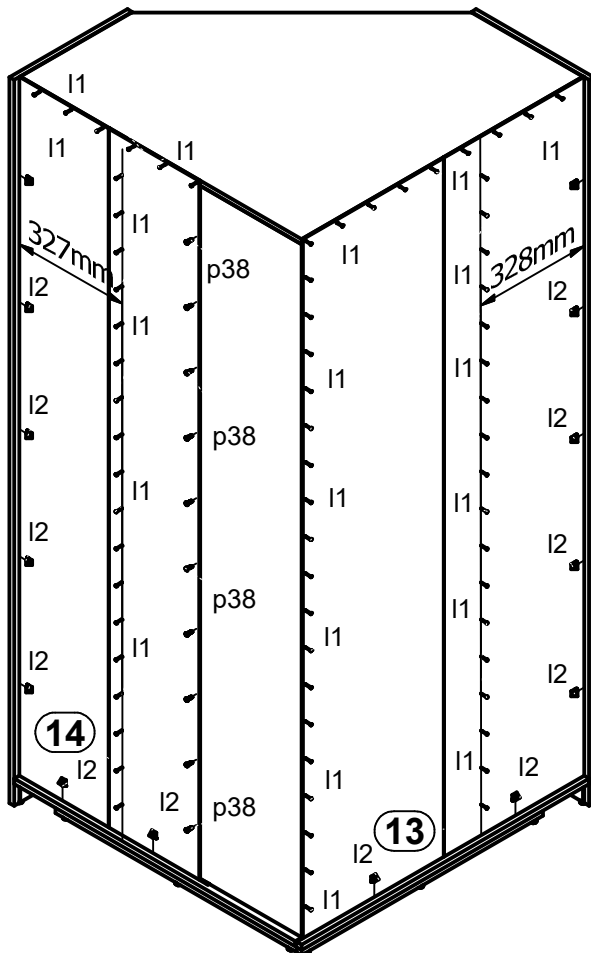

# 7

