

A	B	C	D	A	B	C	D		
1	S404-0010	671	180	3/3	13	S404-4005	1351	160	2/3
2	S404-0011	671	180	3/3	14	S404-4006	1351	60	2/3
3	S404-0012	671	180	3/3	15	S404-5005	1350	70	2/3
4	S404-0013	671	180	3/3	16	S404-5006	1350	70	2/3
5	S404-1006	228	408	1/3	17	S404-5009	620	70	1/3
6	S404-1013	620	428	1/3	18	S404-5010	620	70	1/3
7	S404-1014	620	428	1/3	19	S404-9005	638	355	1/3
8	S404-1015	538	408	1/3	20	S404-9304	547	1469	2/3
9	S404-1016	538	408	1/3	21	ZQ2-1565	628	107	1/3
10	S404-1017	310	408	1/3	22	ZQ3-507	350	120	1/3
11	S404-2004	1491	454	2/3	23	ZQ3-508	350	120	1/3
12	S404-3007	1459	428	2/3					

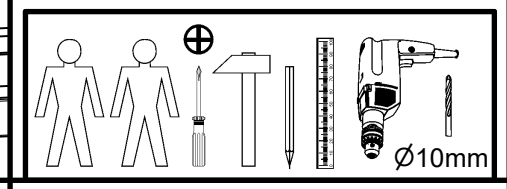

1x d36	7x d37	6x Ø7x50 mm e1	1x Ø6,3x13 mm e2	32x Ø6x13 mm e3	3x Ø7x24 mm e45	26x Ø8x30 mm f1	2x Ø8x40 mm f41	8x Ø6x30 mm f9
2x Ø6x20 mm f13	16x Ø6,5x40 mm f25	4x k1	1x 42,5x42,5x14 mm k38/13	1x 36x30x60 mm k38/18	5x 1,4x20 mm l1	14x l2	4x Ø3,5x16 mm p25	4x Ø3,5x10 mm p35
50x Ø3,5x16 mm p38	8x Ø2,9x16 mm p55	24x Ø15x12 mm #16 r1	16x Ø12x10,5 mm #12 r15	36x 20/11 r42	2x 40 mm r51	4x 350 mm t35	4x 350mm w167/L	4x 350mm w167/P
1x 4 mm z1						1x n26/1	1x Ø3,5x16 mm p38	

1

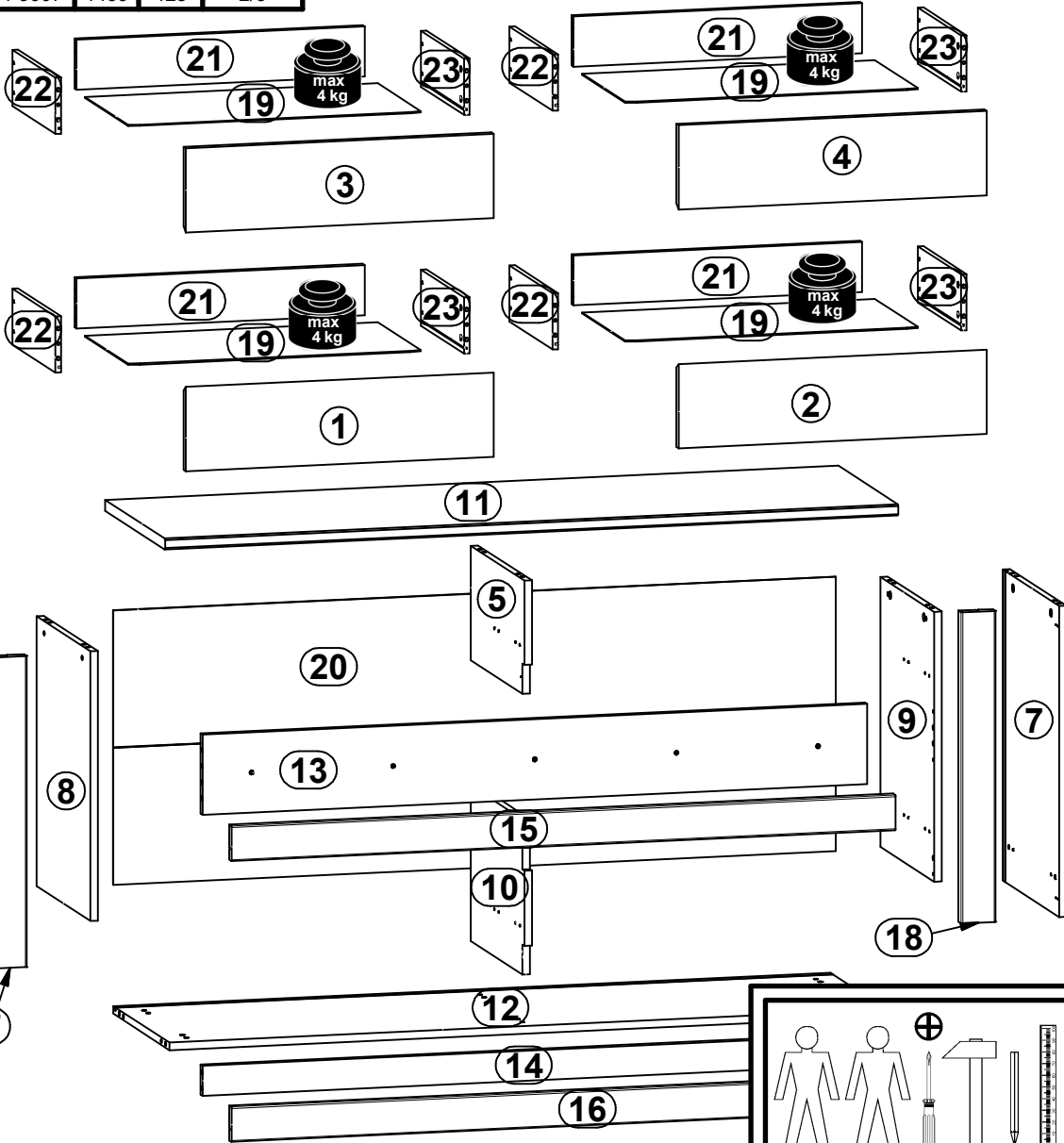
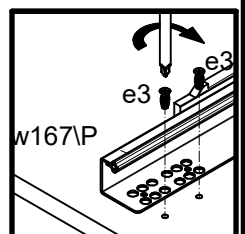
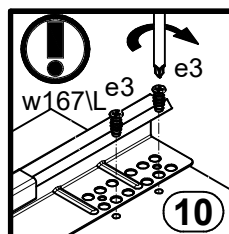
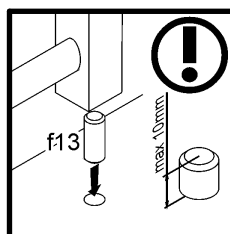
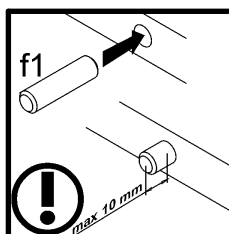
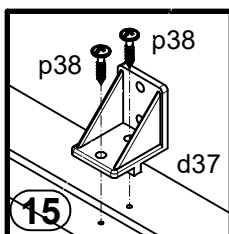
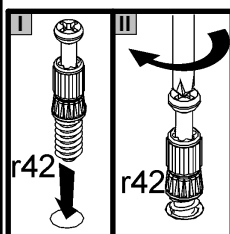
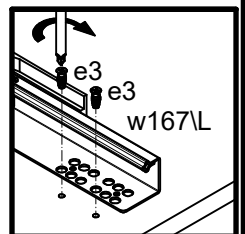
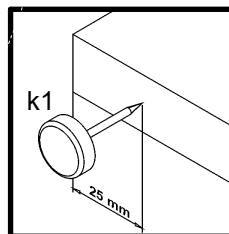
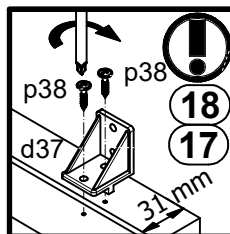
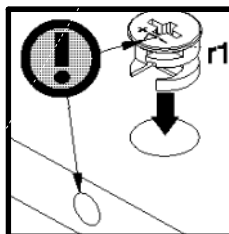
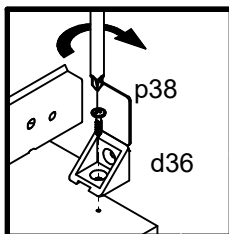
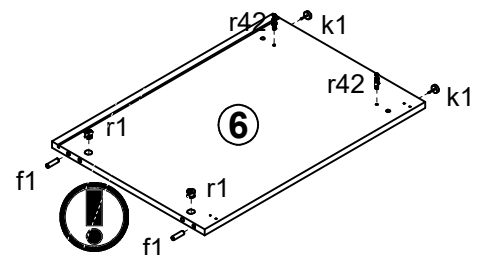
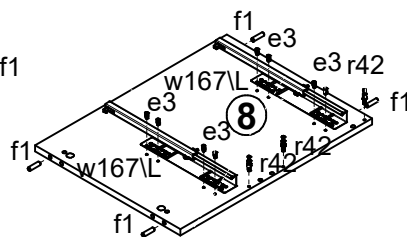
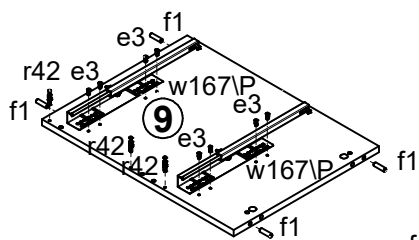
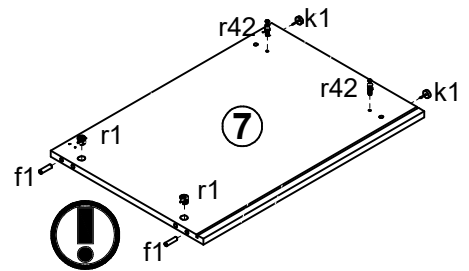
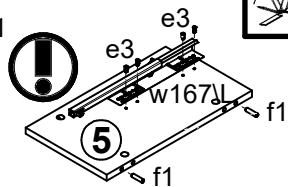
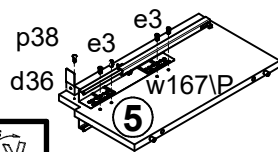
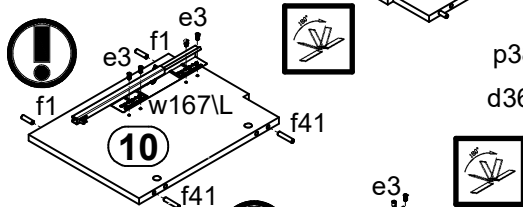
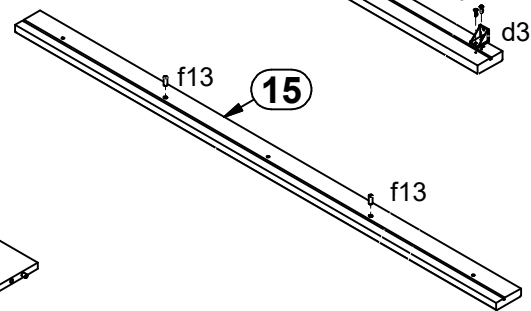
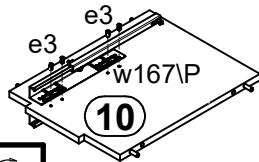
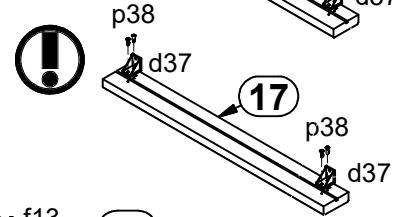
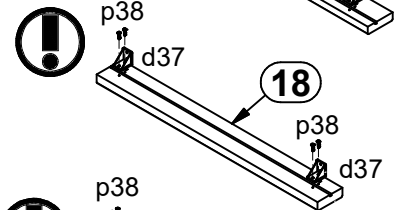
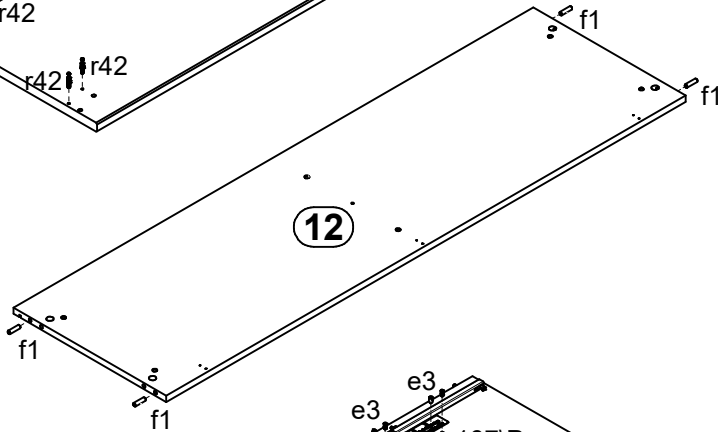
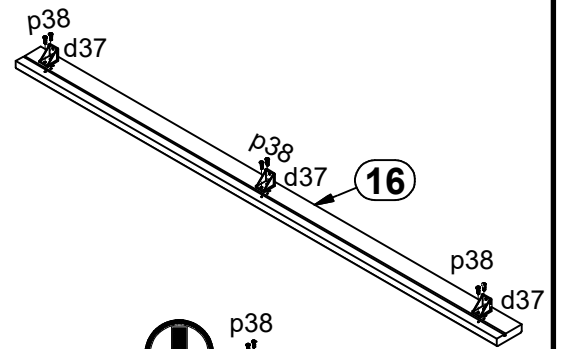
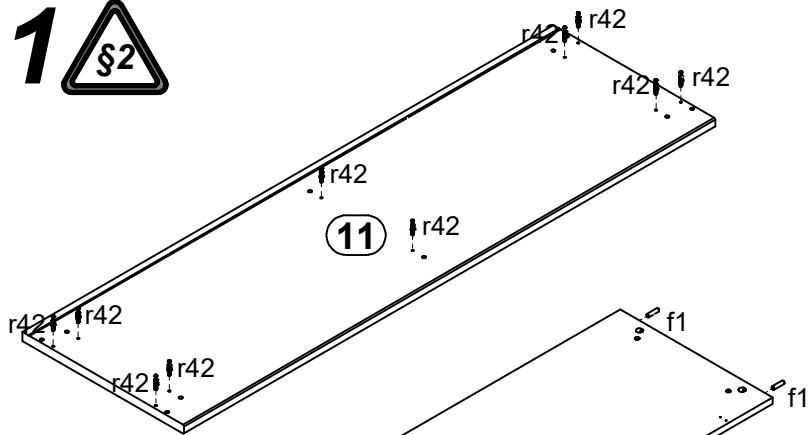

2

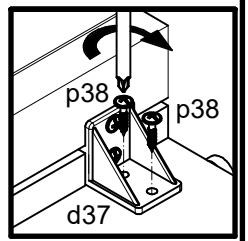
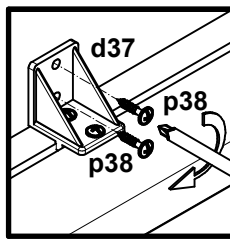
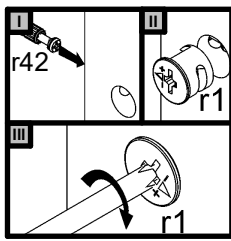
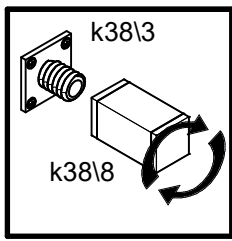
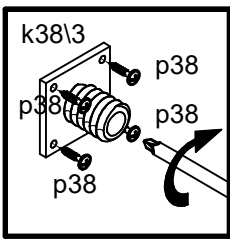
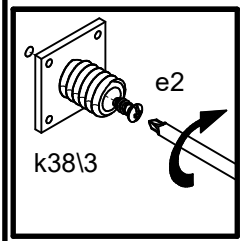
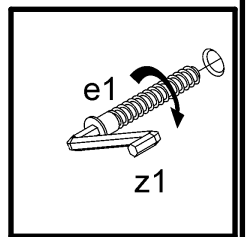
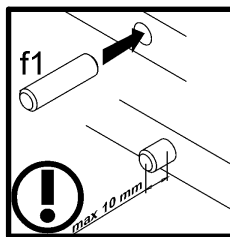
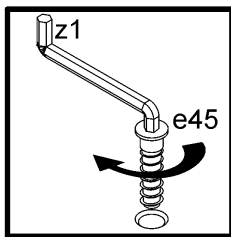
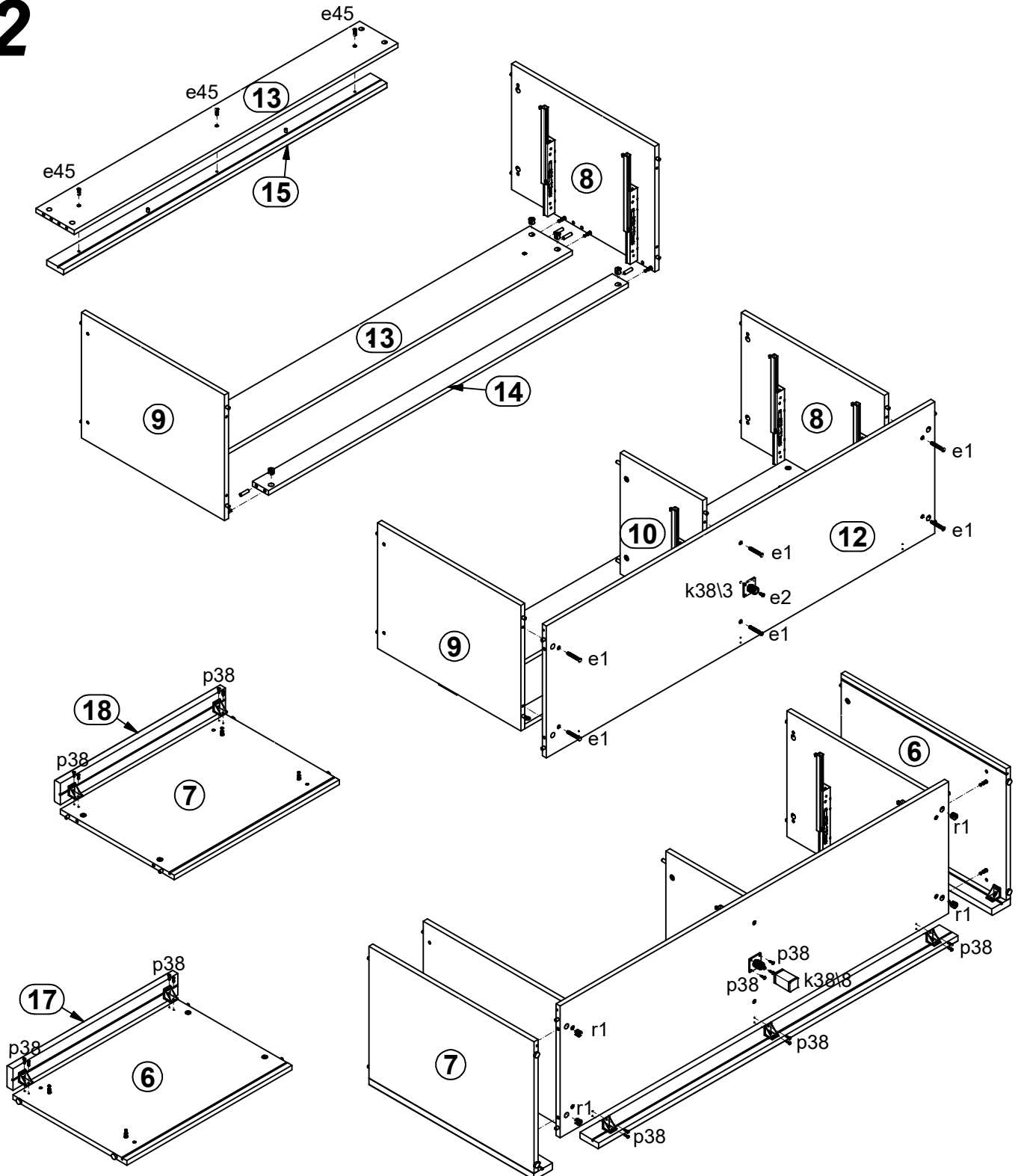

3

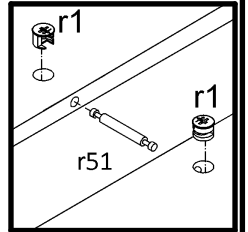
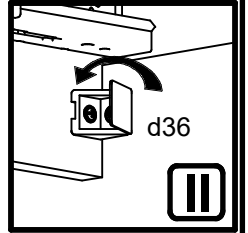
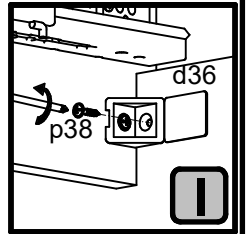
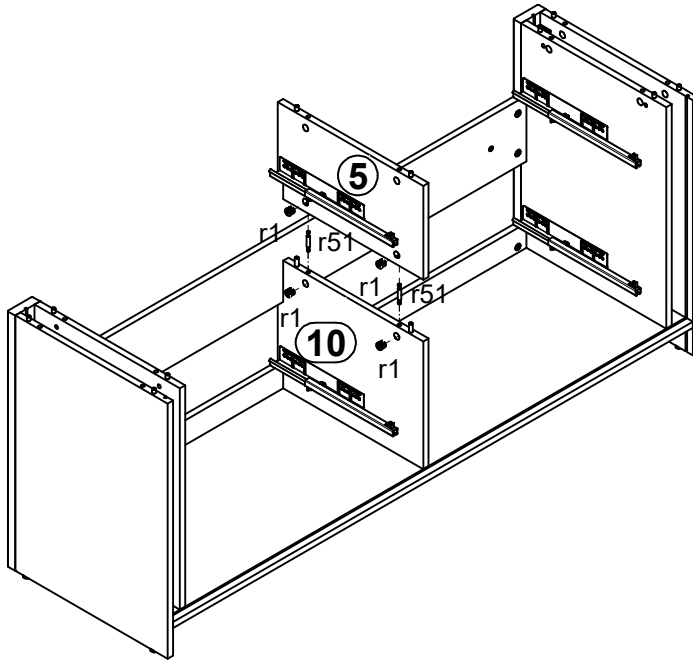

4

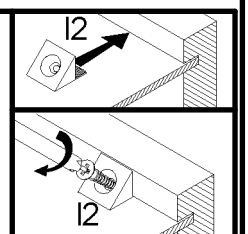
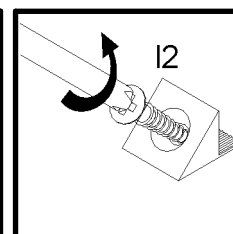
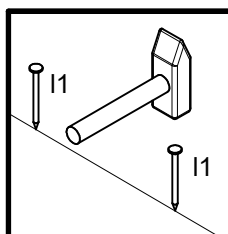
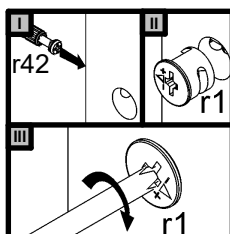
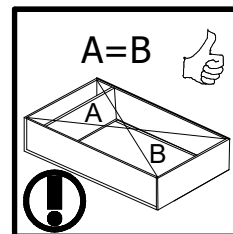
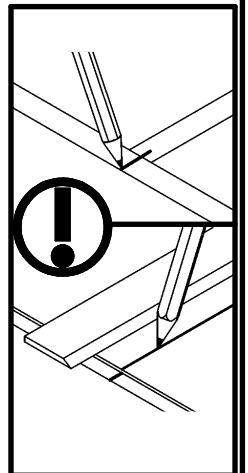
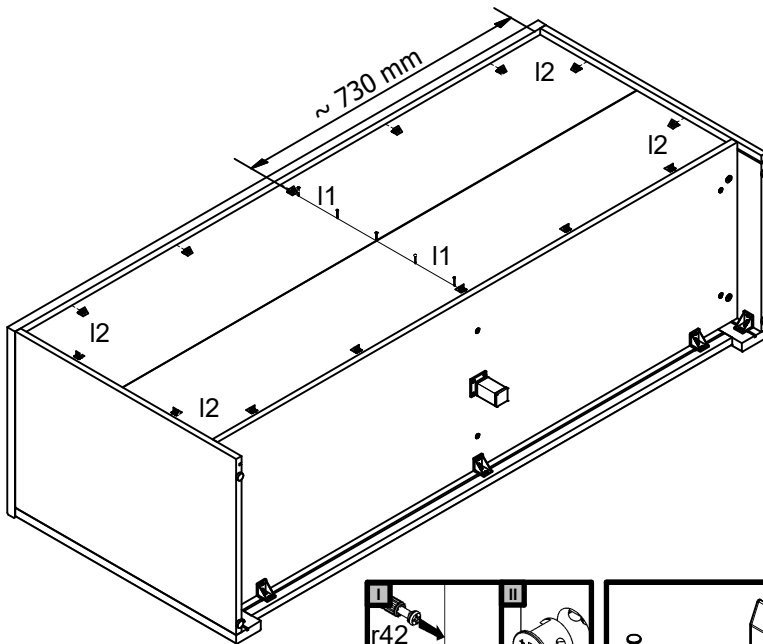
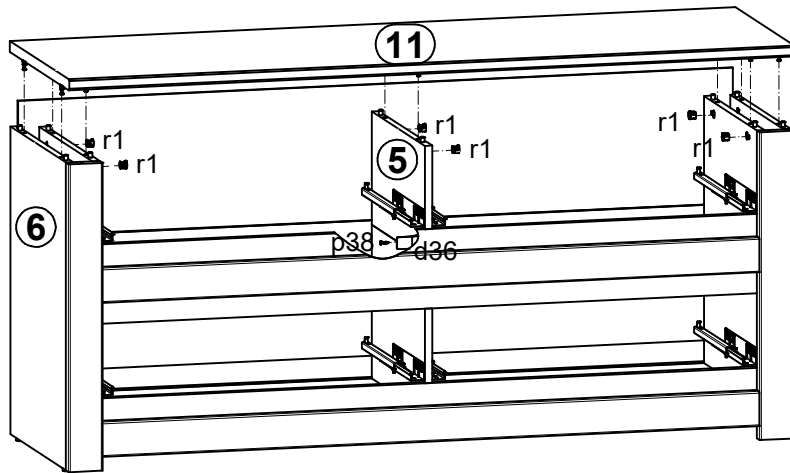

5

4x

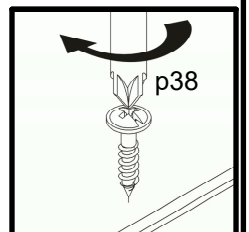
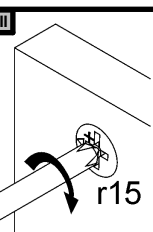
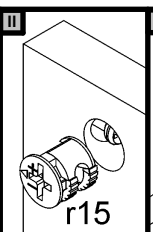
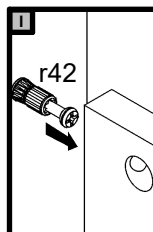
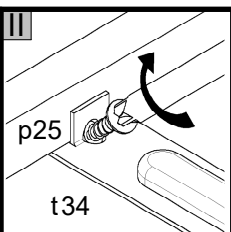
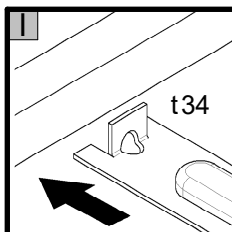
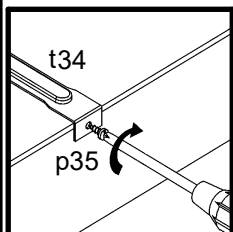
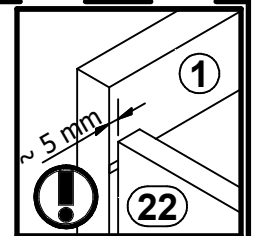
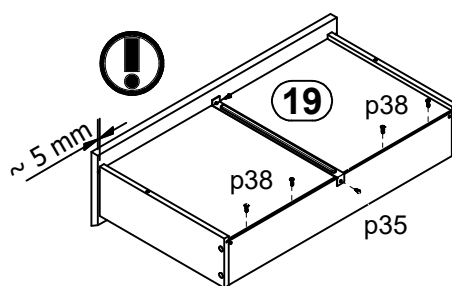
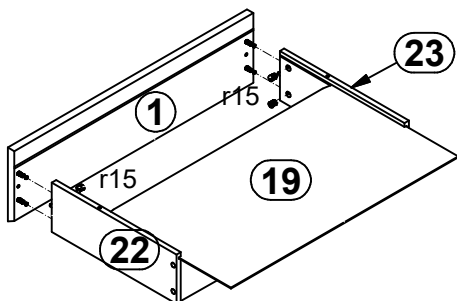
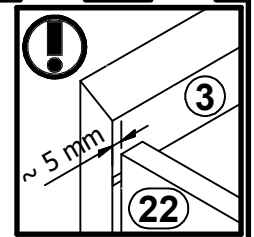
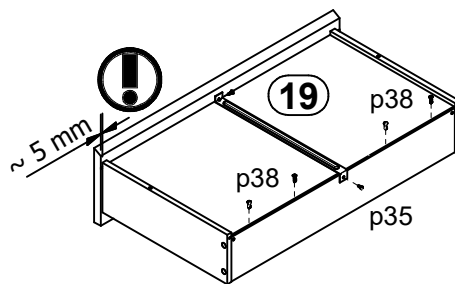
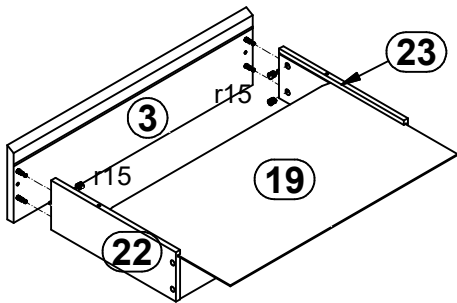
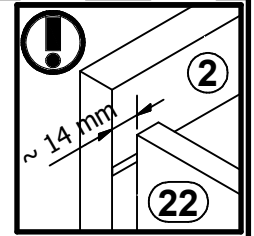
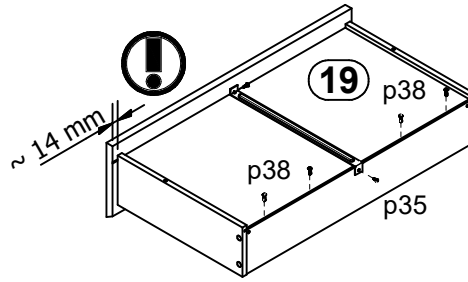
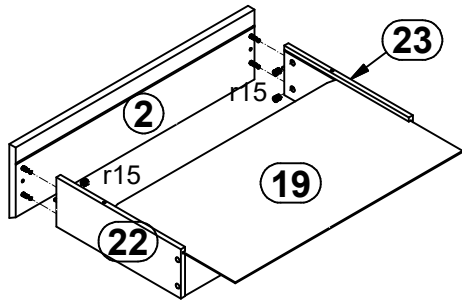
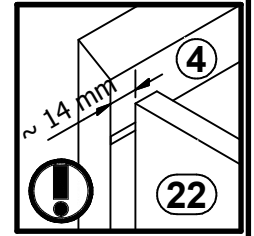
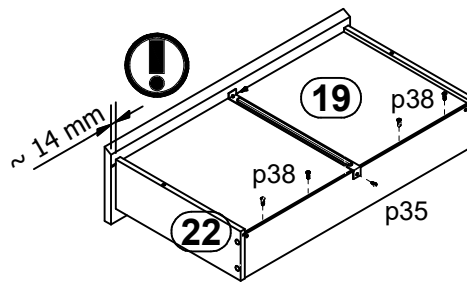
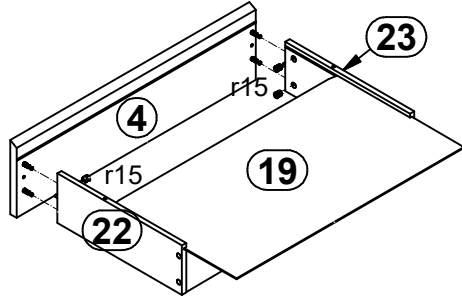
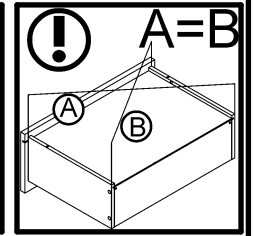
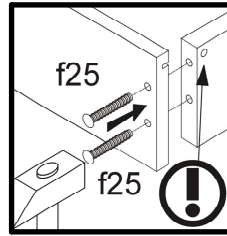
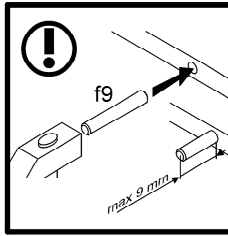
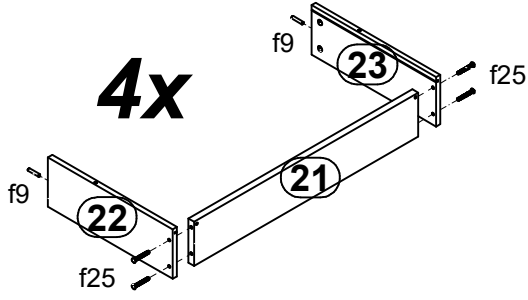

6

