

| A | B | C | D | |
|----|----------|------|-----|-----|
| 1 | S322-003 | 794 | 240 | 4/4 |
| 2 | S322-004 | 1616 | 396 | 3/4 |
| 3 | S322-103 | 1968 | 540 | 1/4 |
| 4 | S322-104 | 1968 | 540 | 1/4 |
| 5 | S322-202 | 884 | 551 | 2/4 |
| 6 | S322-301 | 800 | 537 | 2/4 |
| 7 | S322-402 | 800 | 80 | 2/4 |
| 8 | S322-403 | 800 | 80 | 2/4 |
| 9 | S322-904 | 773 | 505 | 2/4 |
| 10 | S322-906 | 1925 | 825 | 1/4 |
| 11 | ZS3-5620 | 751 | 200 | 2/4 |
| 12 | ZS4-541 | 500 | 200 | 2/4 |
| 13 | ZS4-542 | 500 | 200 | 2/4 |
| 14 | dr-792 | 792 | 22 | 2/4 |

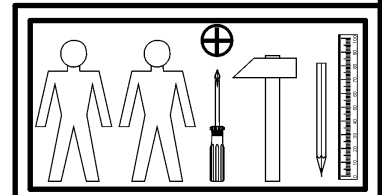

| | | | | | | | | |
|--------------------------|----------------------------|------------------------------|------------------------|----------------------|------------------------|-------------------------|-------------------------|-------------------------|
| 8x k16 a43 | 8x b19 | 3x M4 c415 | 4x Ø6,3x15 mm d4 | 6x Ø6x13 mm e3 | 6x Ø5x9 mm e19 | 12x Ø8x30 mm f1 | 2x Ø6x30 mm f9 | 4x Ø6,5x40 mm f25 |
| 3x M4x20 mm j1 | 4x k1 | 65x l1 | 2x h=22mm n1 | 1x n26 | 2x Ø3,5x13 mm p1 | 1x Ø3,5x16 mm p25 | 1x Ø3,5x10 mm p35 | 7x Ø3,5x16 mm p38 |
| 16x Ø3,5x15 mm p51 | 16x Ø15x12 mm #16 r1 | 4x Ø12x10,5 mm #12 r15 | 20x 20/11 r42 | 6x Ø16 s2 | 1x 500 mm t34 | 1x 500 mm w26\CL | 1x 500 mm w26\CR | 1x 500 mm w26\DL |
| 1x 500 mm w26\DR | | | | | | | | |

1

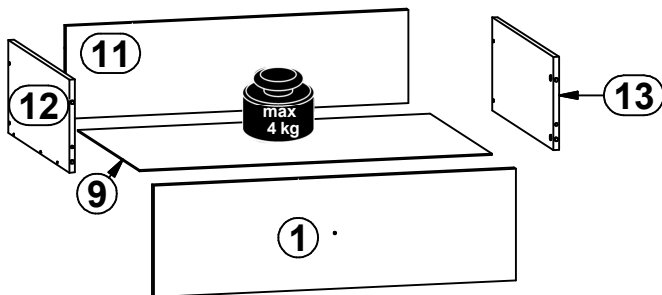
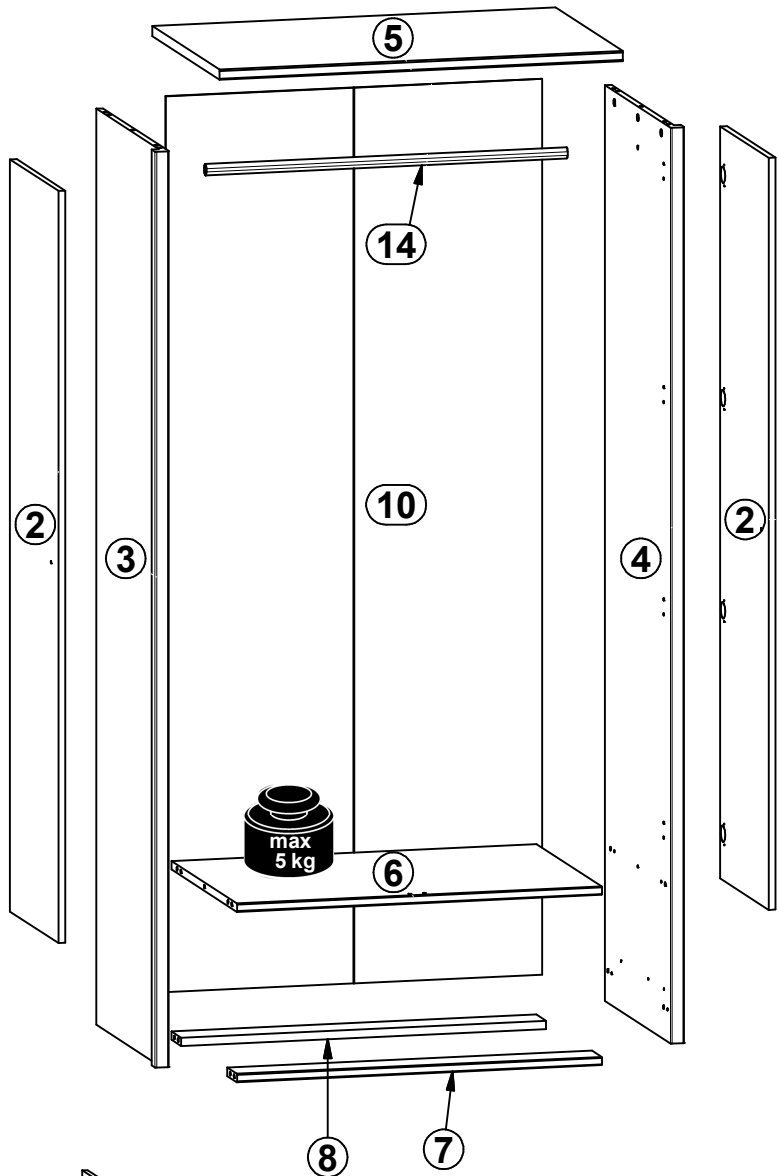
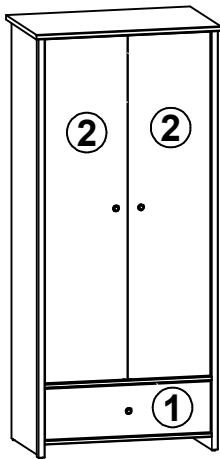
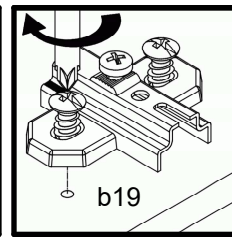
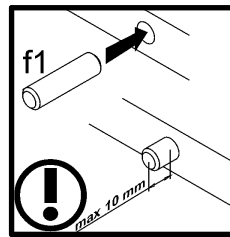
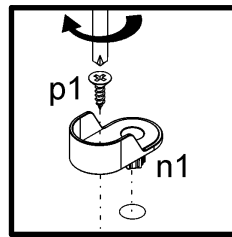
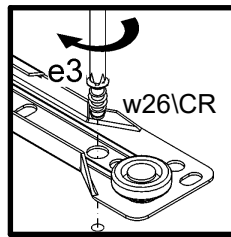
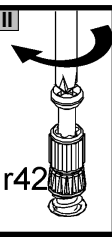
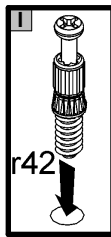
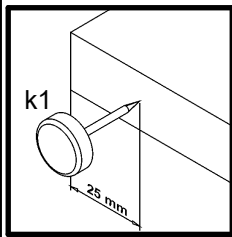
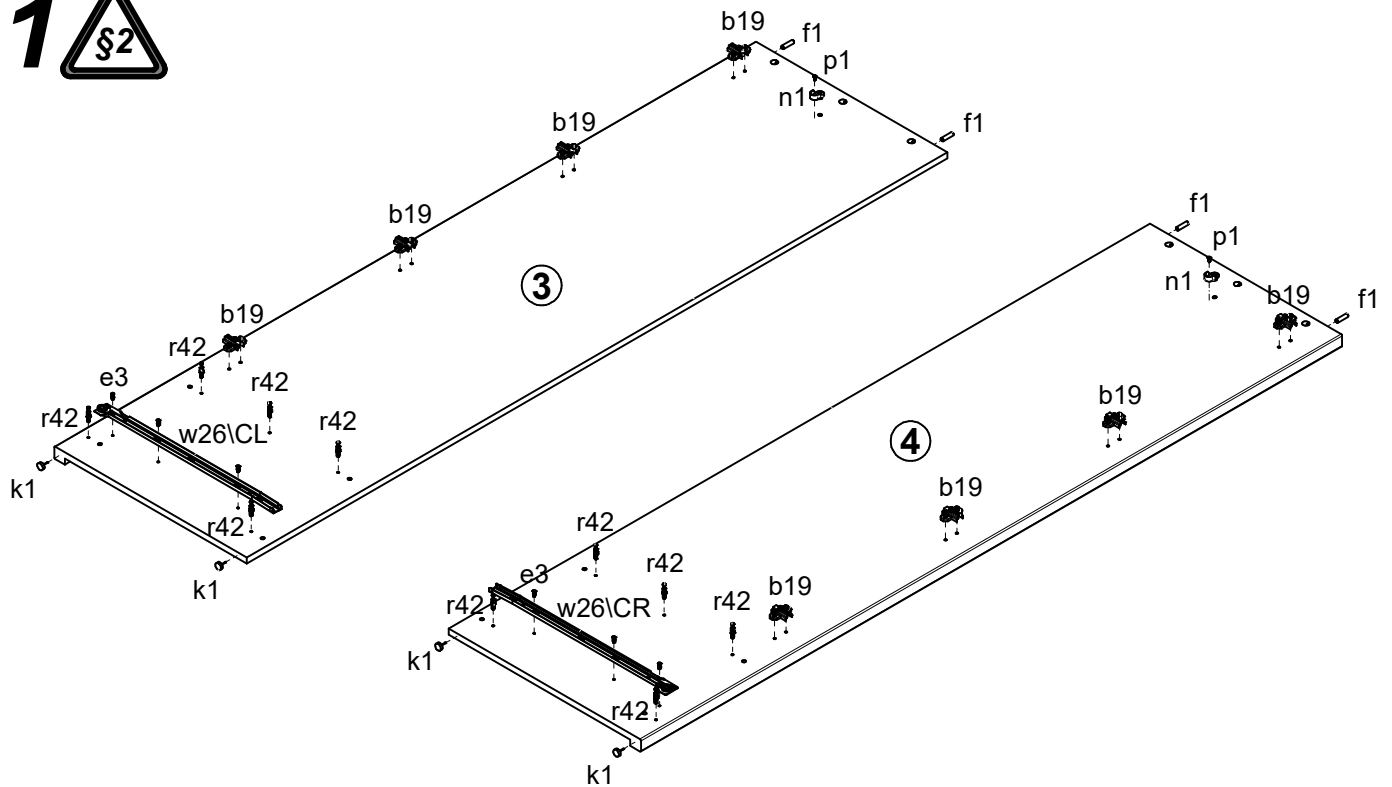

2

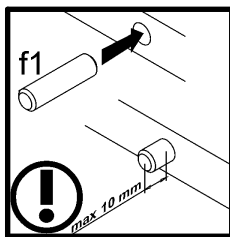
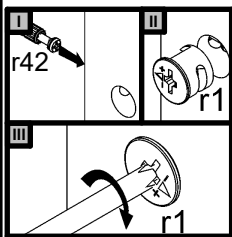
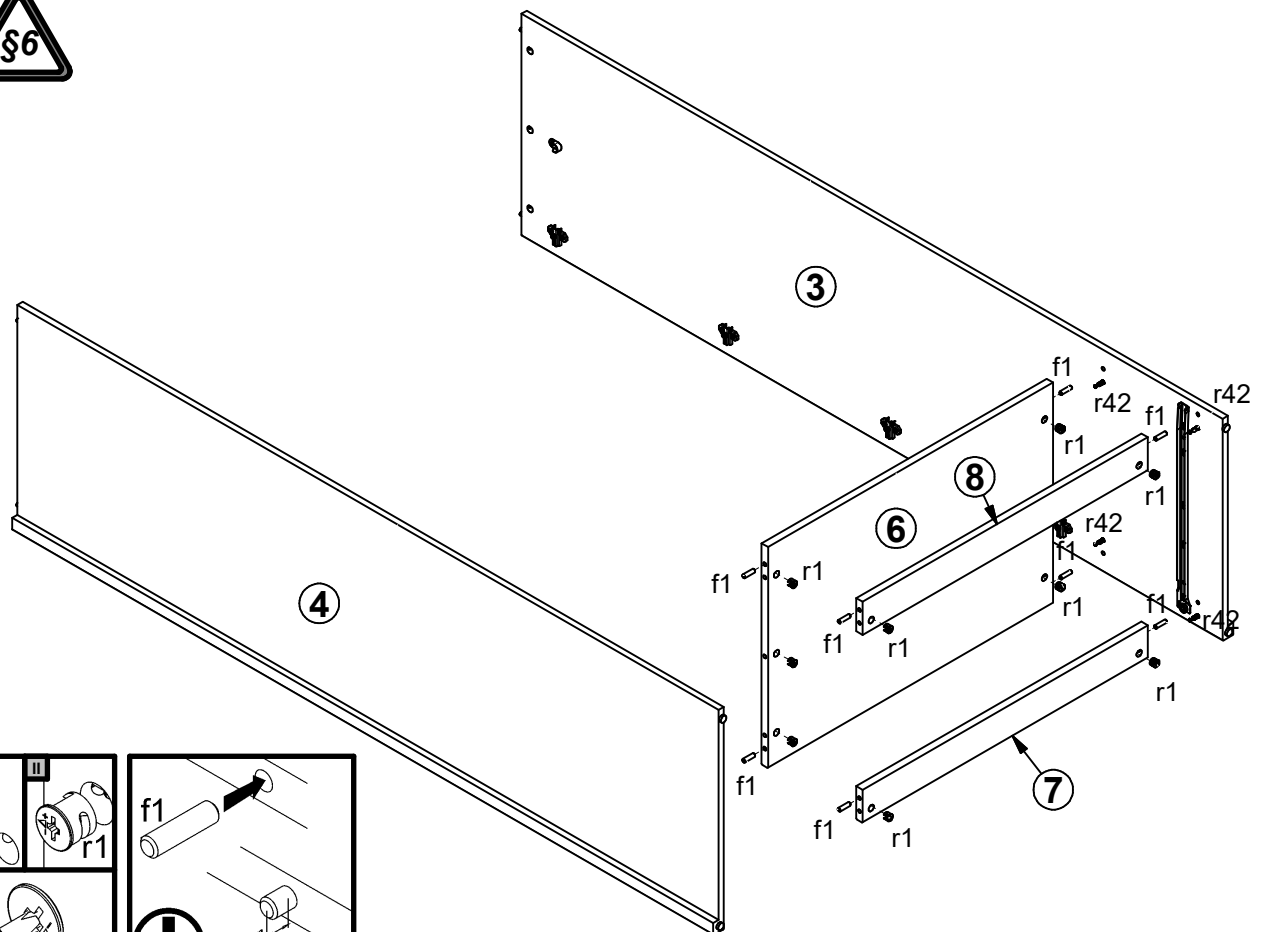

3

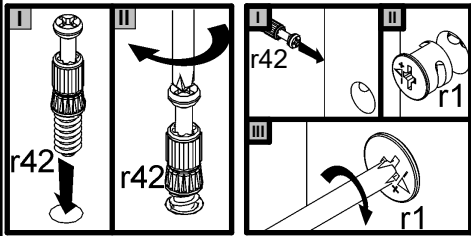
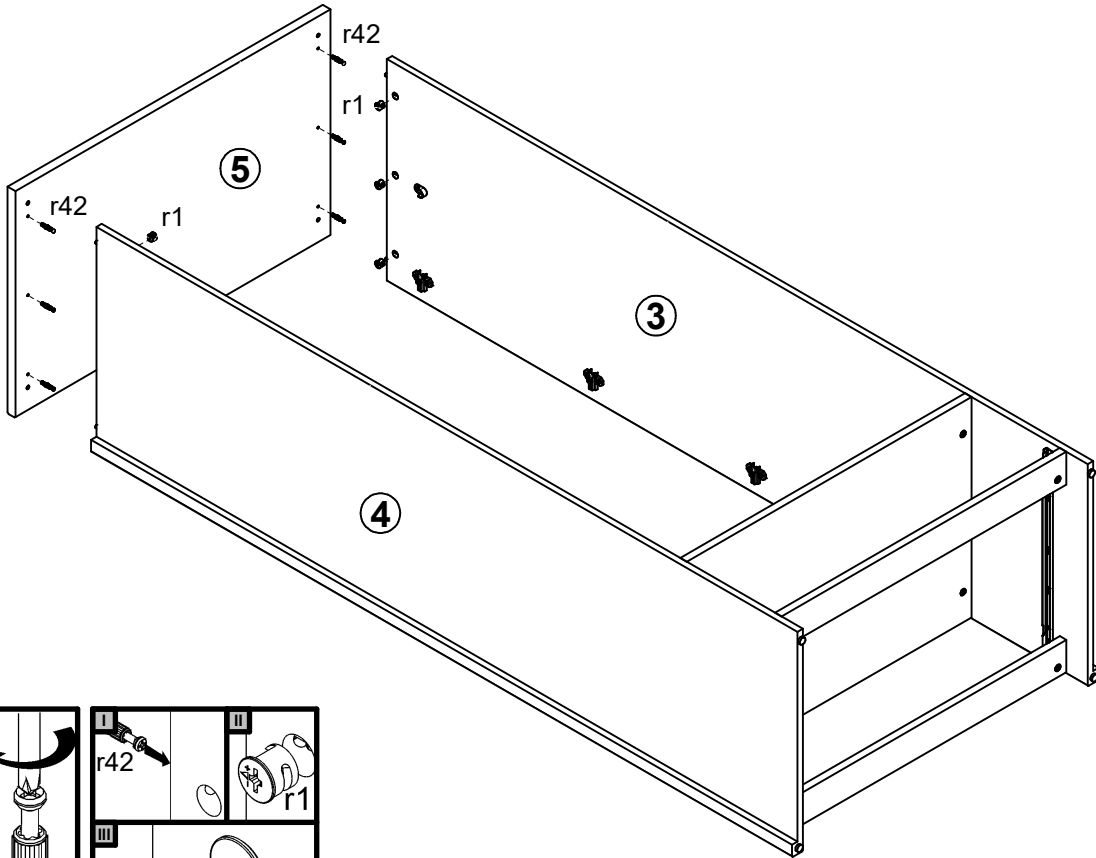

4

