

A	B	C	D
1	S325-001	1564	396
2	S325-002	796	191
3	S325-010	796	191
4	S325-101	2032	540
5	S325-102	2032	540
6	S325-201	800	565
7	S325-301	767	540
8	S325-401	767	80
9	S325-901	1995	793
10	S325-902	740	505
11	ZS3-5645	718	120
12	ZS4-505	500	120
13	ZS4-506	500	120
17	dr-761	761	22

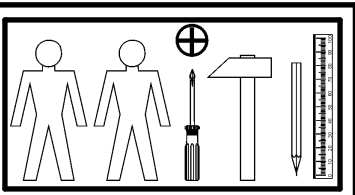

6x a44	6x b19	4x c417	12x e1	12x e3	12x e19	12x f1	4x f9	8x f25
8x j30	4x k1	60x l1	2x n1	1x n25	1x n26	8x o21	2x p1	2x p25
2x p27	2x p35	19x p38	12x p51	8x r15	8x r42	8x s1	2x t34	2x w26\CL
2x w26\CR	2x w26\DL	2x w26\DR	1x z1					

# 1

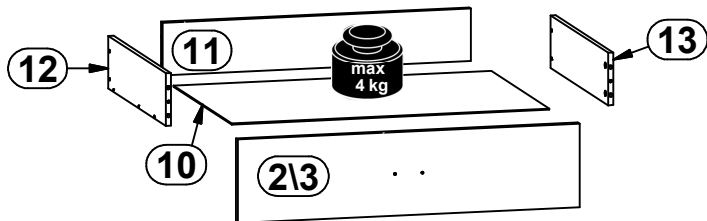
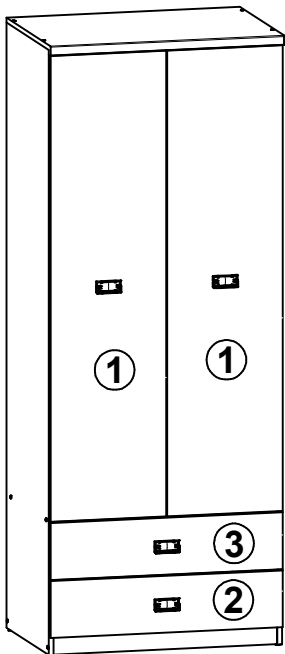
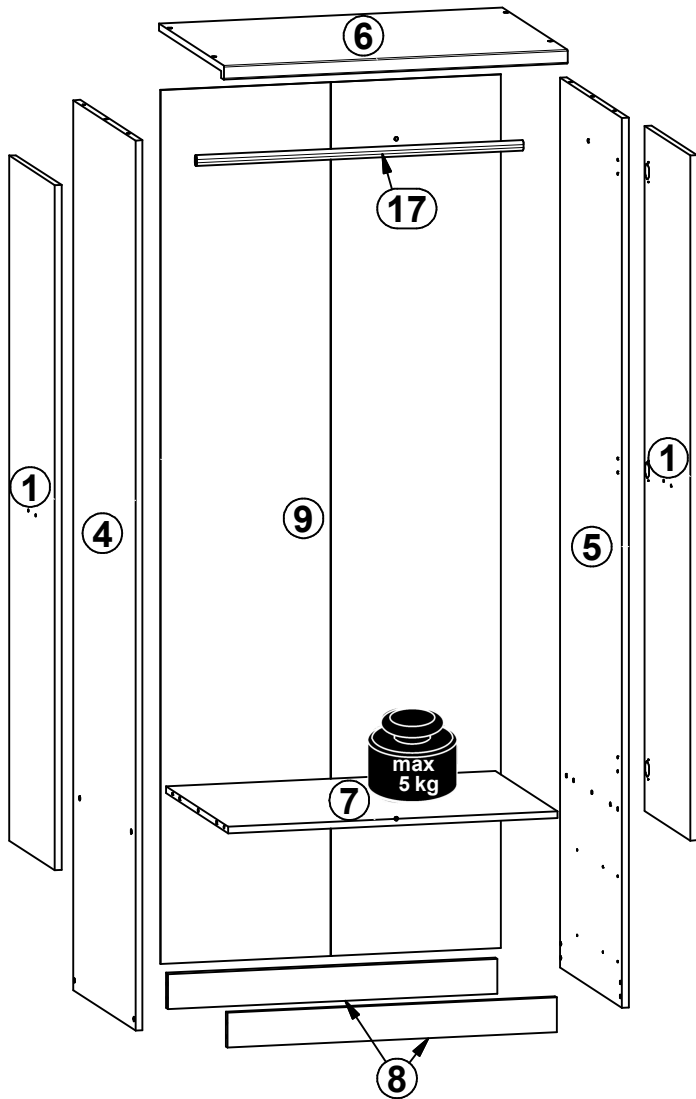
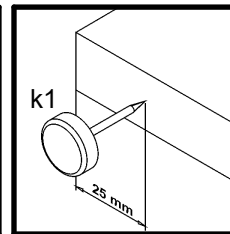
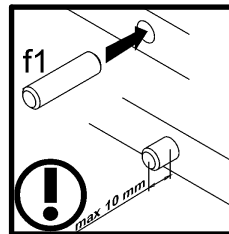
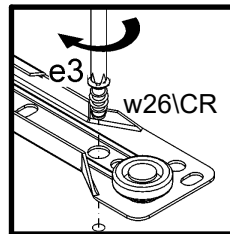
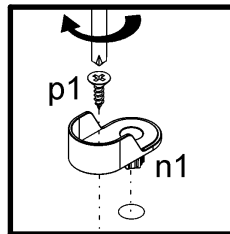
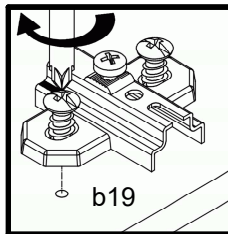
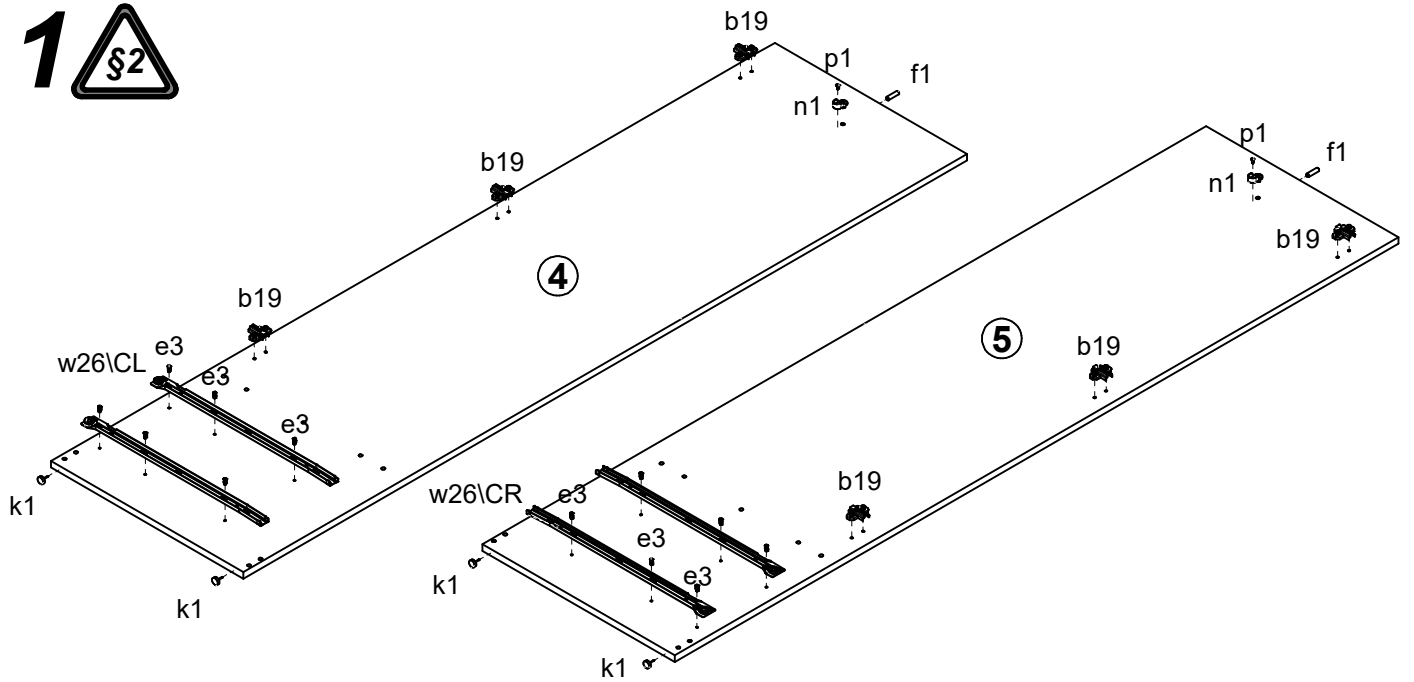

# 2

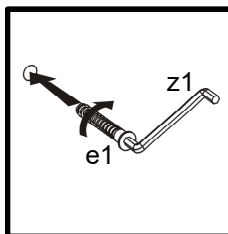
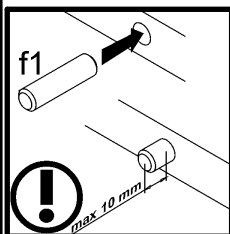
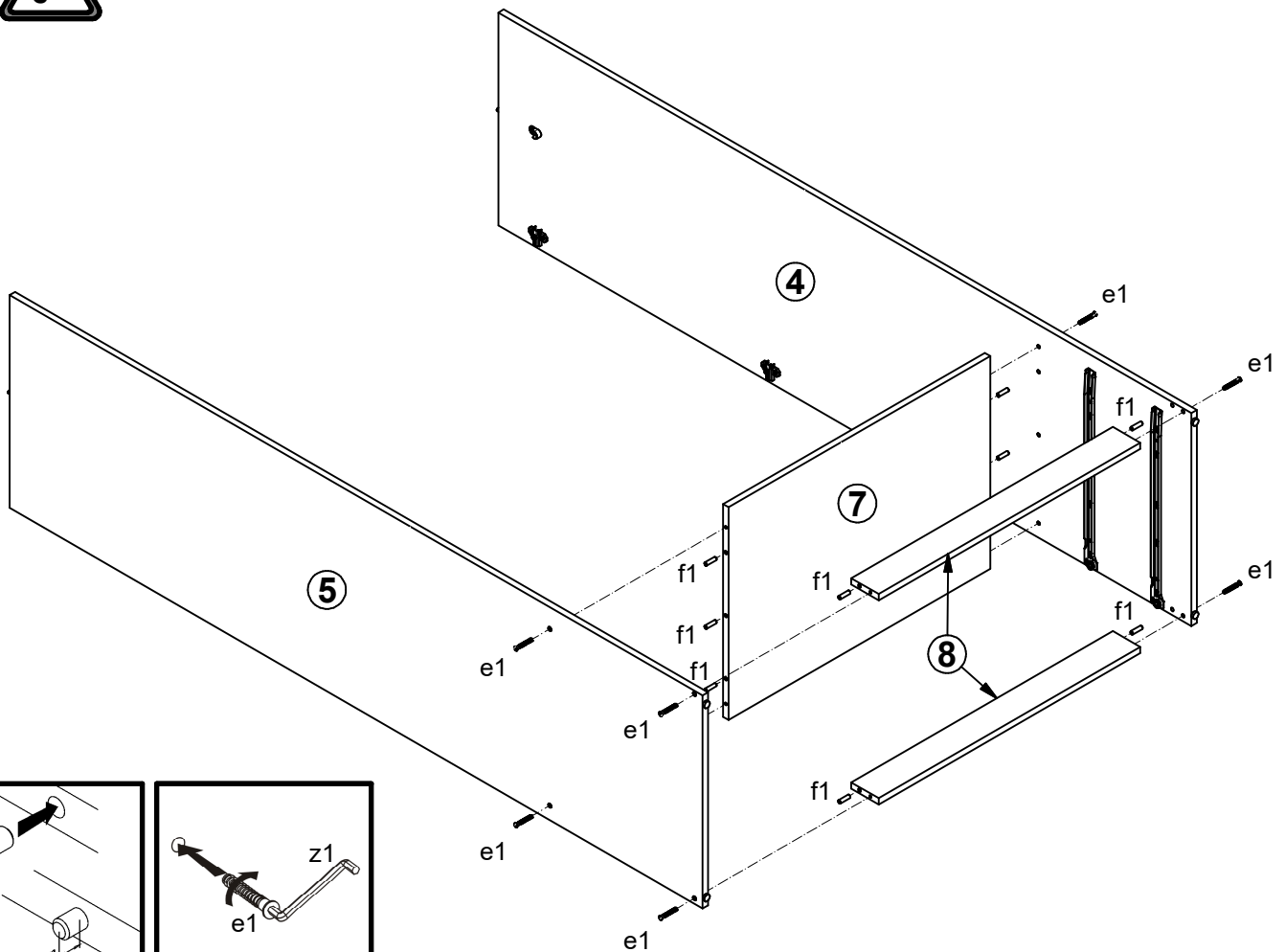

# 3

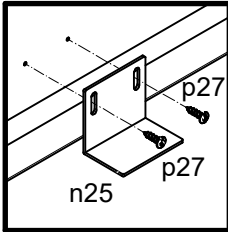
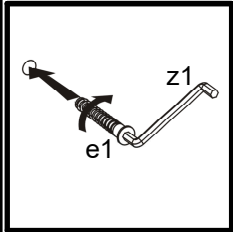
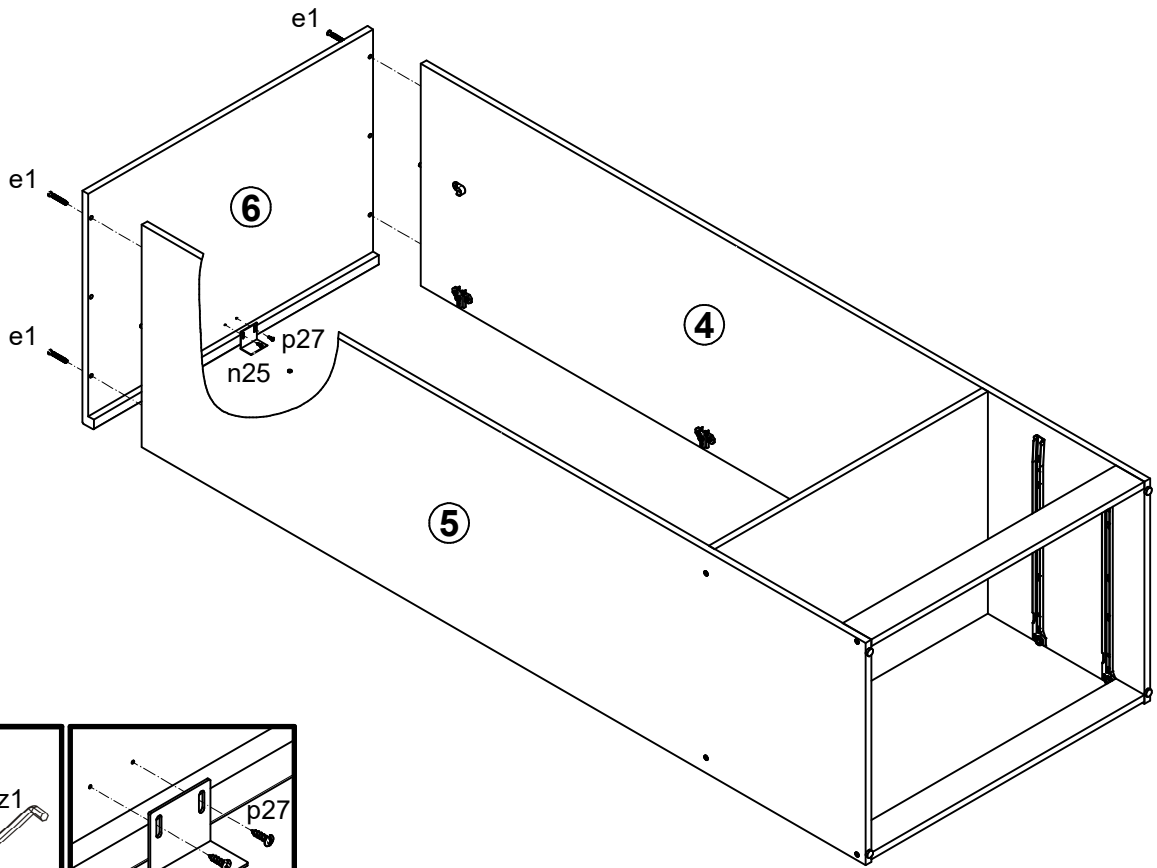

# 4

