

A	B	C1	C2	C3	D
1	S504-0030	604	596	16	2/2
2	S504-1043	1870	390	15	1/2
3	S504-1044	1870	390	15	1/2
4	S504-2003	600	390	15	1/2
5	S504-2004	600	390	15	1/2
6	S504-3016	569	360	15	1/2
7	S504-3017	568	360	15	1/2
8	S504-3018	562	340	4	2/2
9	S504-3022	569	354	15	1/2
10	S504-5554	746	564	3	2/2
11	S504-7314	403	596	16	2/2
12	S504-7322	200	596	16	2/2
13	S504-9308	1880	579	2,5	1/2
14	qc33\1				1/2
15	S504-5702	569	68	16	2/2
16	S504-4033	569	68	15	2/2

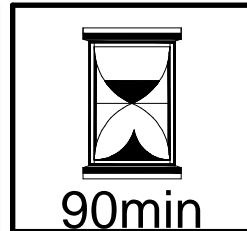

5x a102	5x H2 b59	4x Ø5x17 mm d1	4x d38	2x d41\2	4x Ø7x50 mm e1	6x Ø5x16 mm e47	20x Ø8x30 mm f1	18x l1	18x I2	4x k27	6x Ø5,3\Ø6,3x4,8 mm o54	10x Ø3,5x16 mm p38
10x Ø3,5x15 mm p51	16x Ø15x12 mm #16 r1	16x r42	10x Ø5 s4	5x Ø35x62x40x10 S71	12x Ø16 s2	1x z1	2x Ø10x50 mm f35	2x 36x21x15\1,5 n14\2	2x Ø5x60 mm p17	4x Ø3,5x16 mm p38		

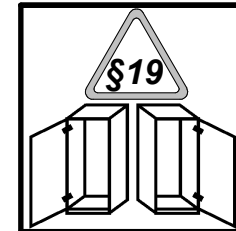

1 

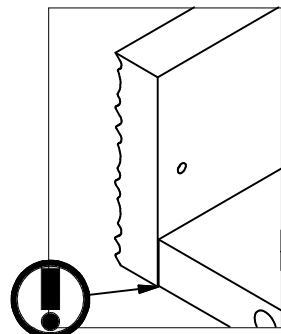
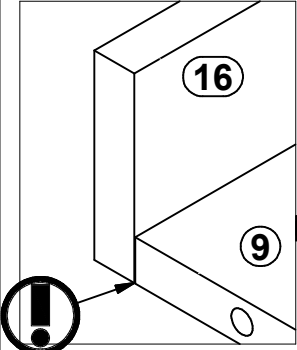
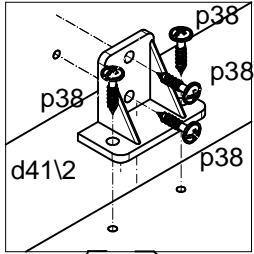
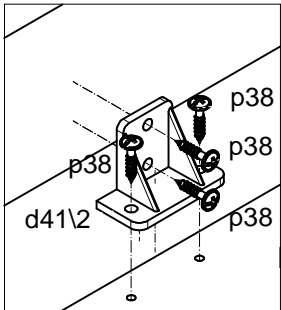
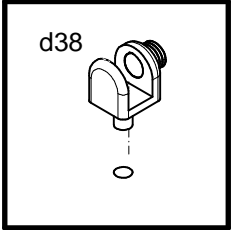
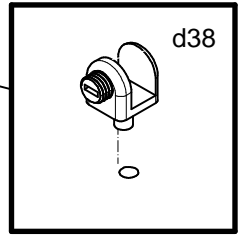
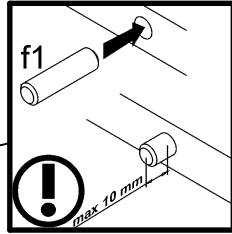
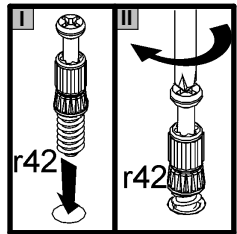
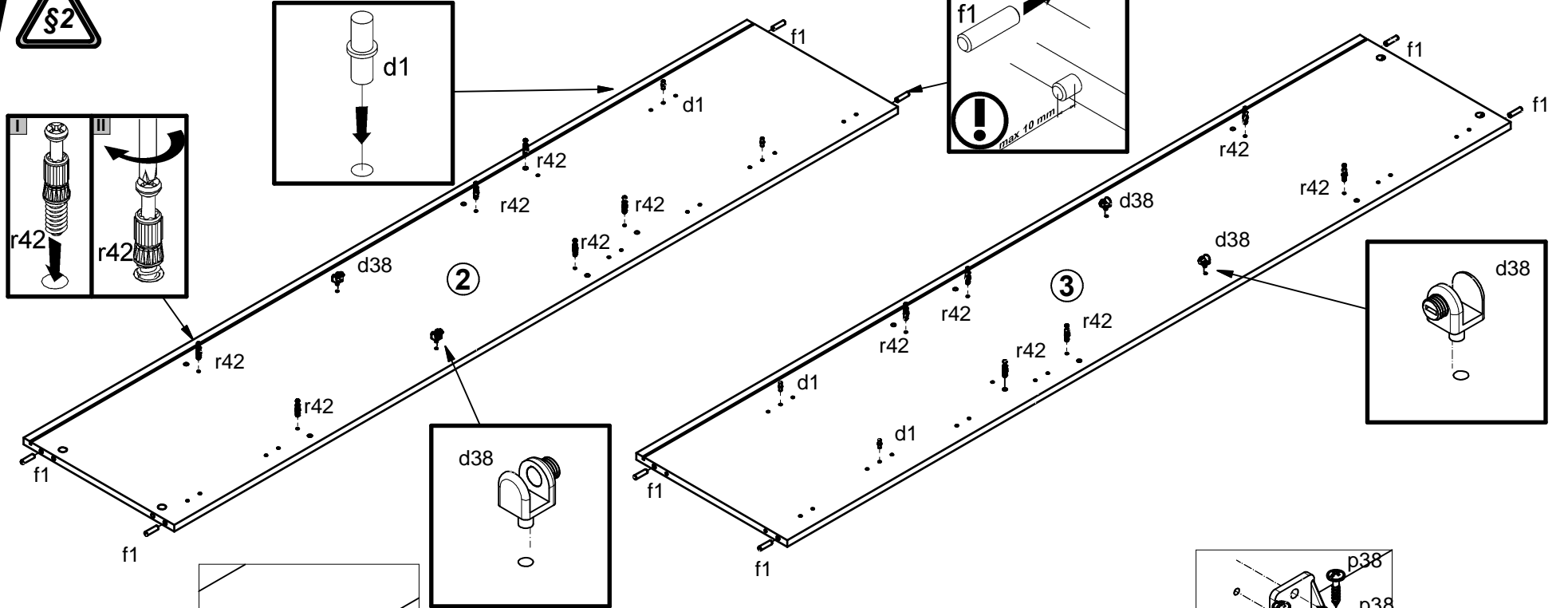

1

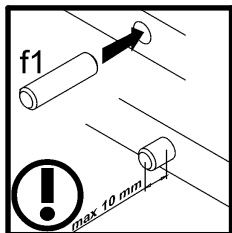

2

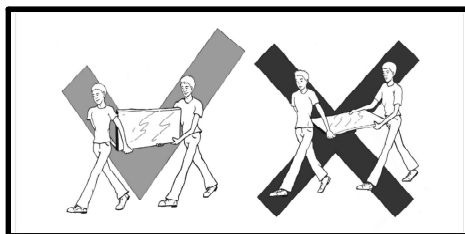
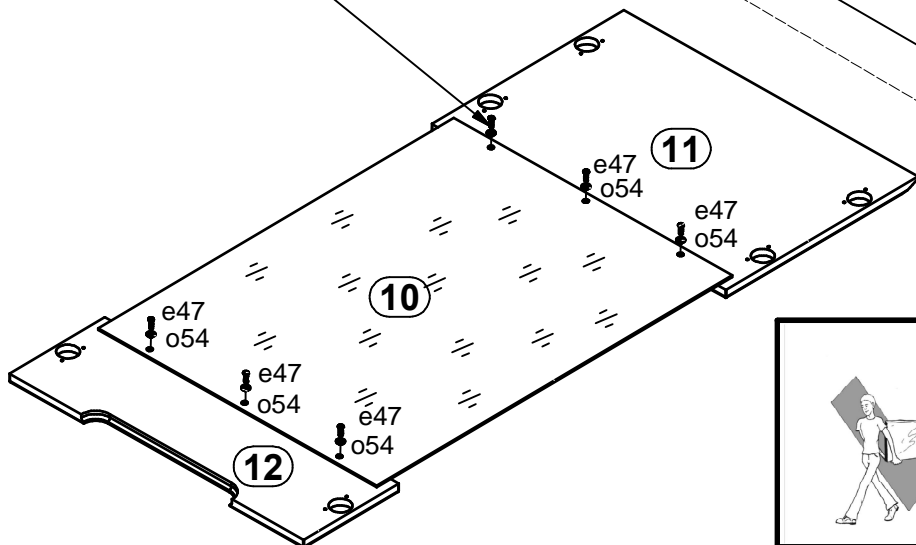
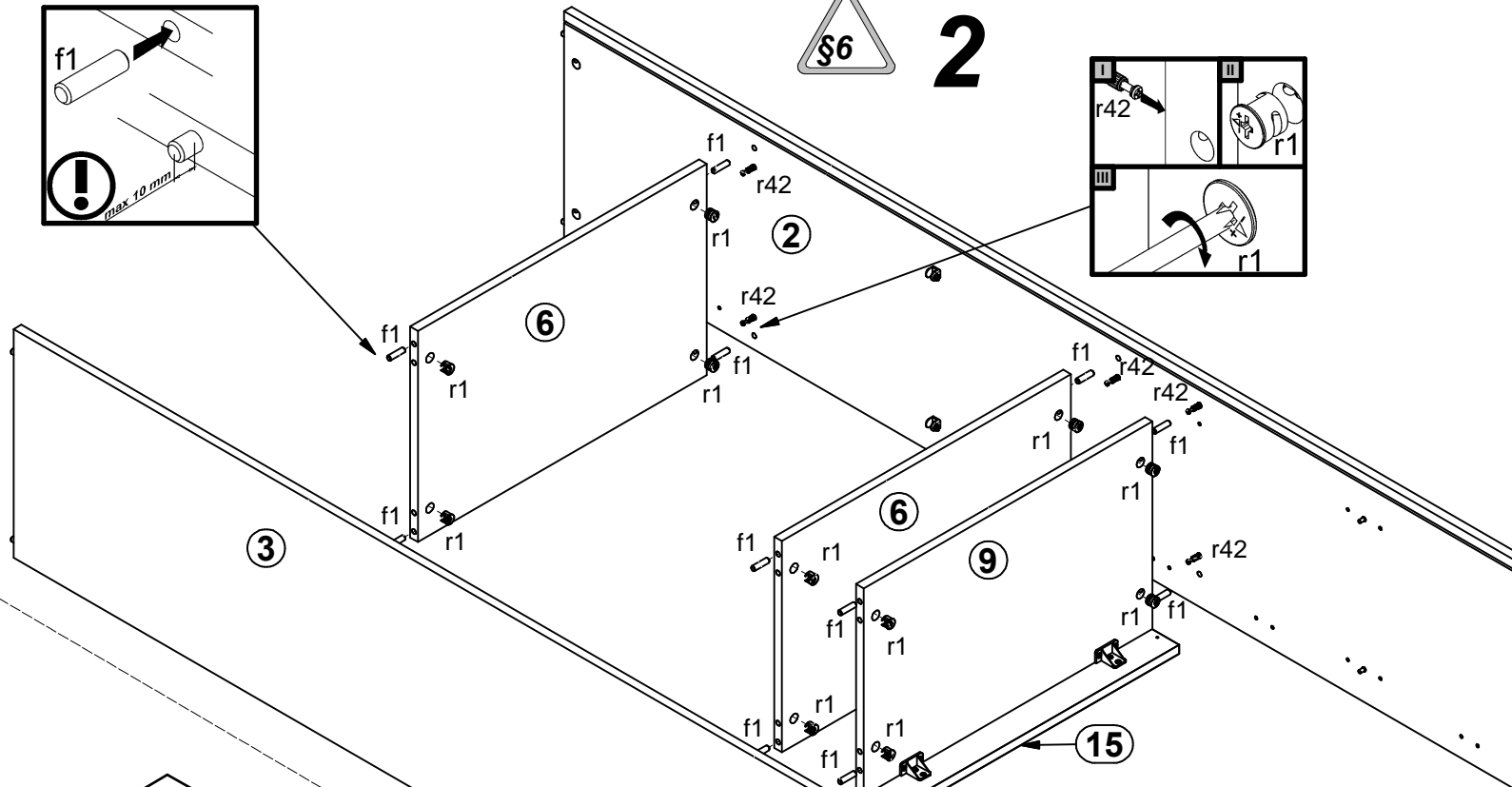
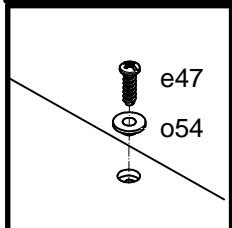
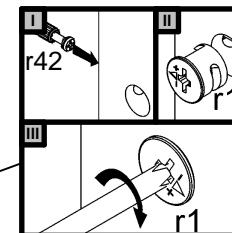

3

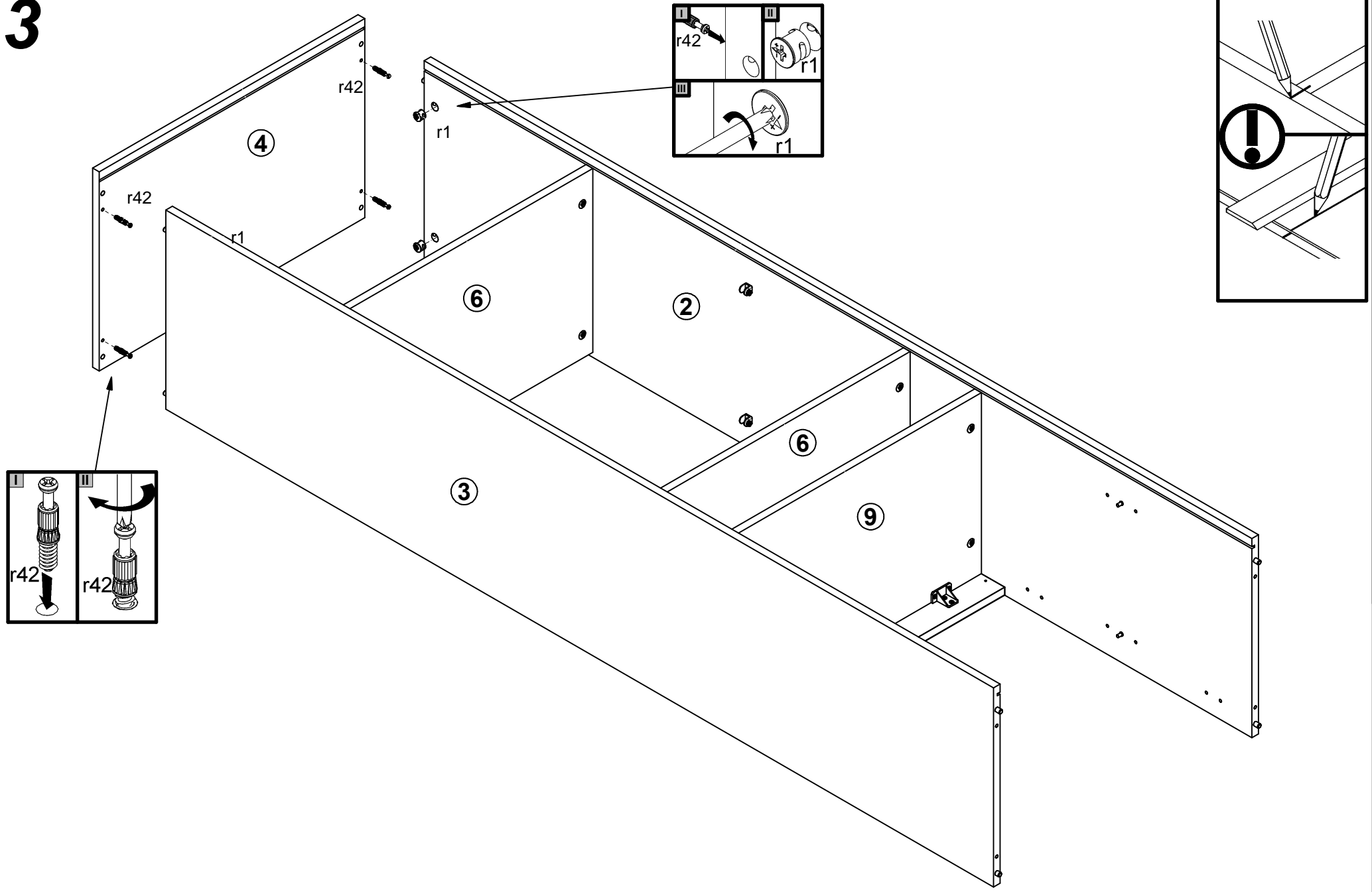

5

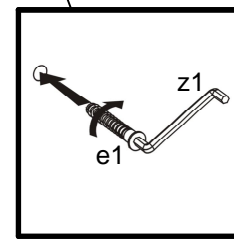
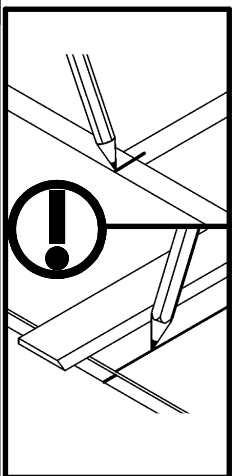
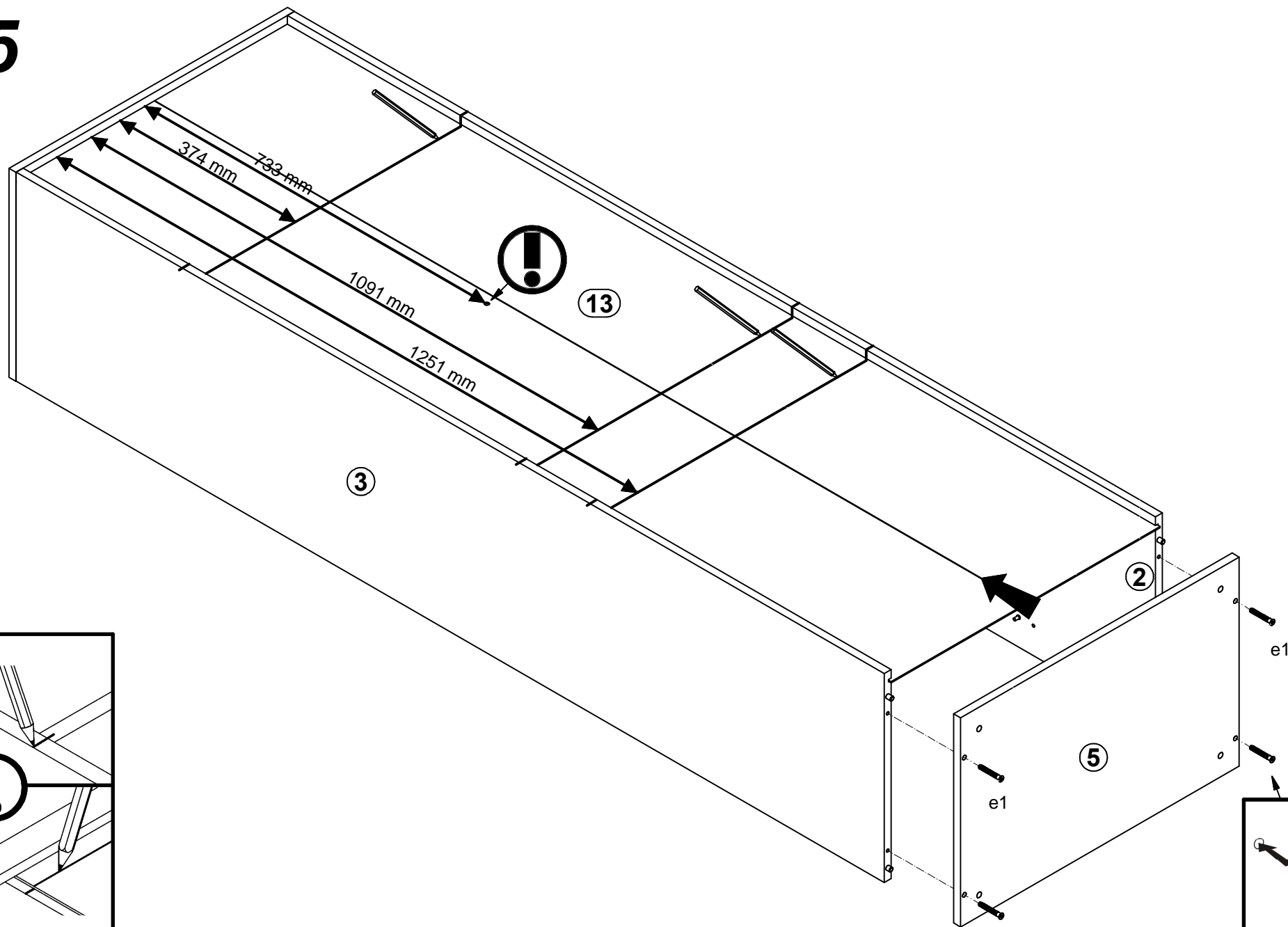

6

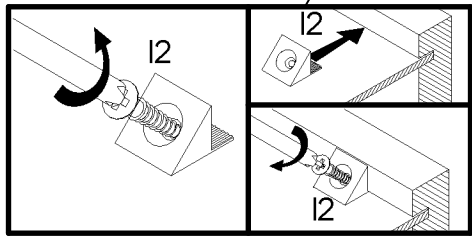
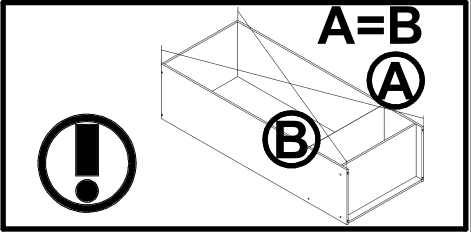
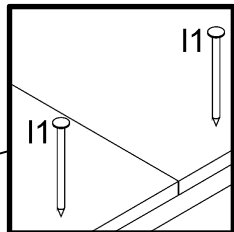
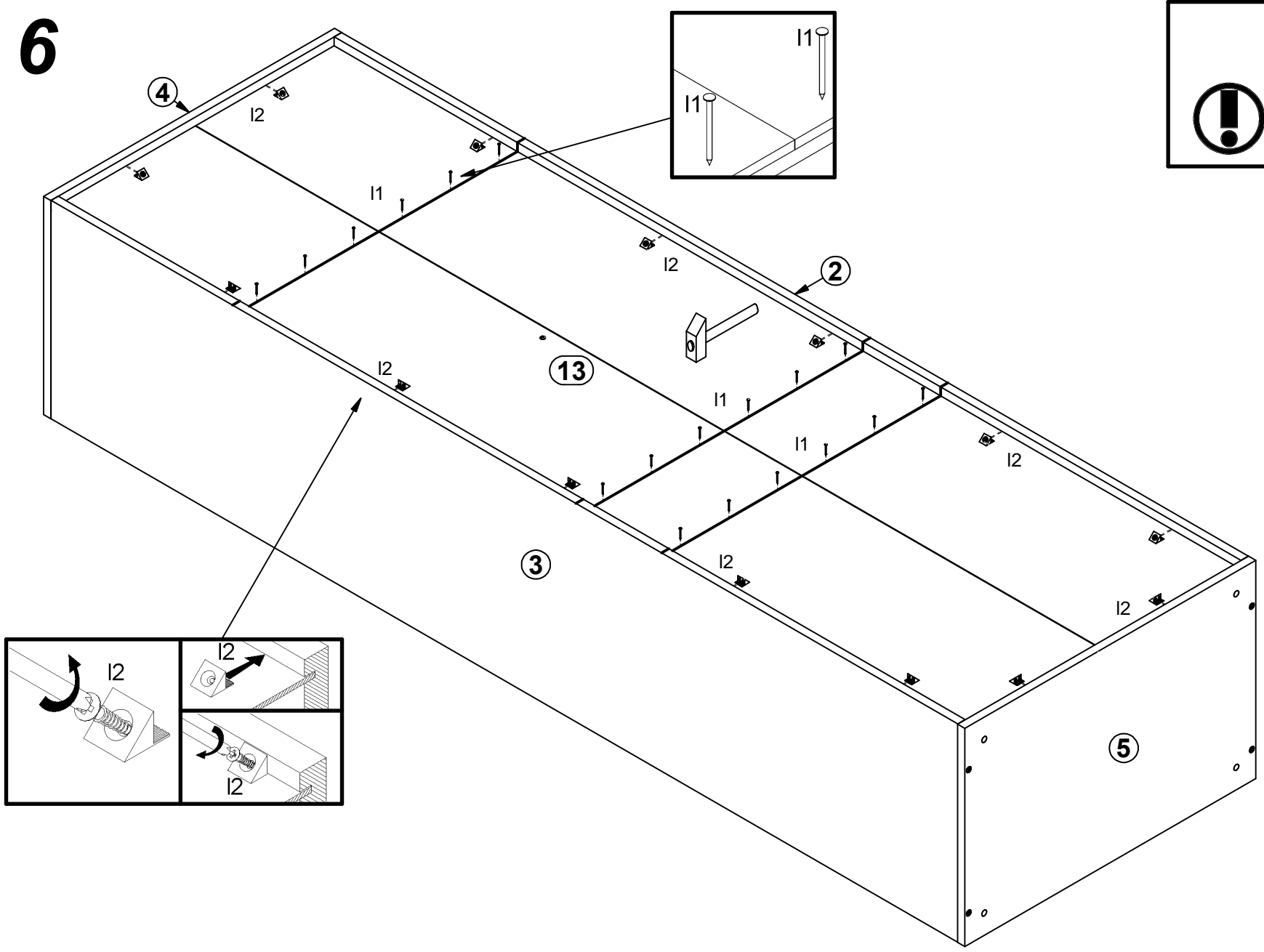

6

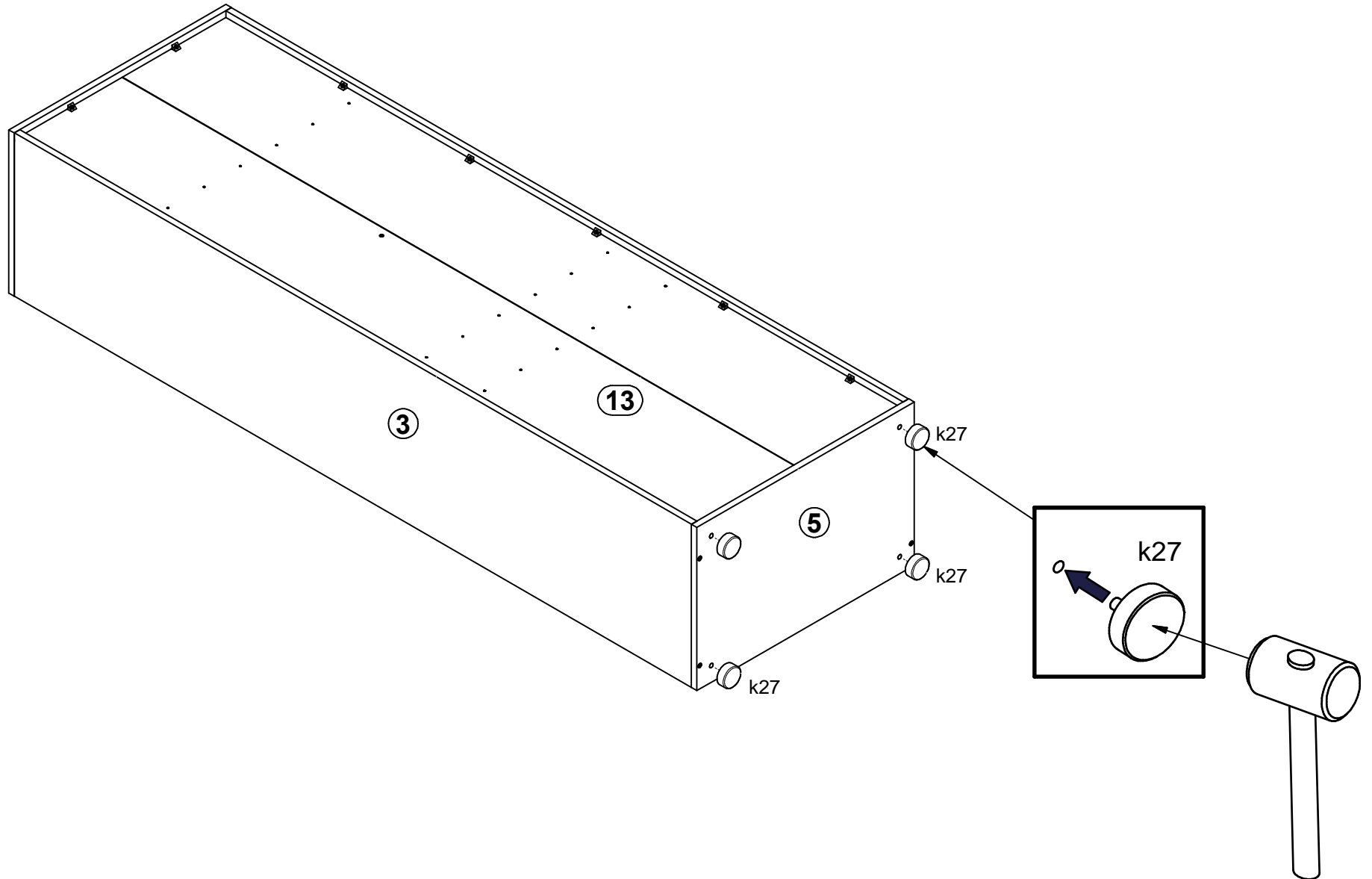

7

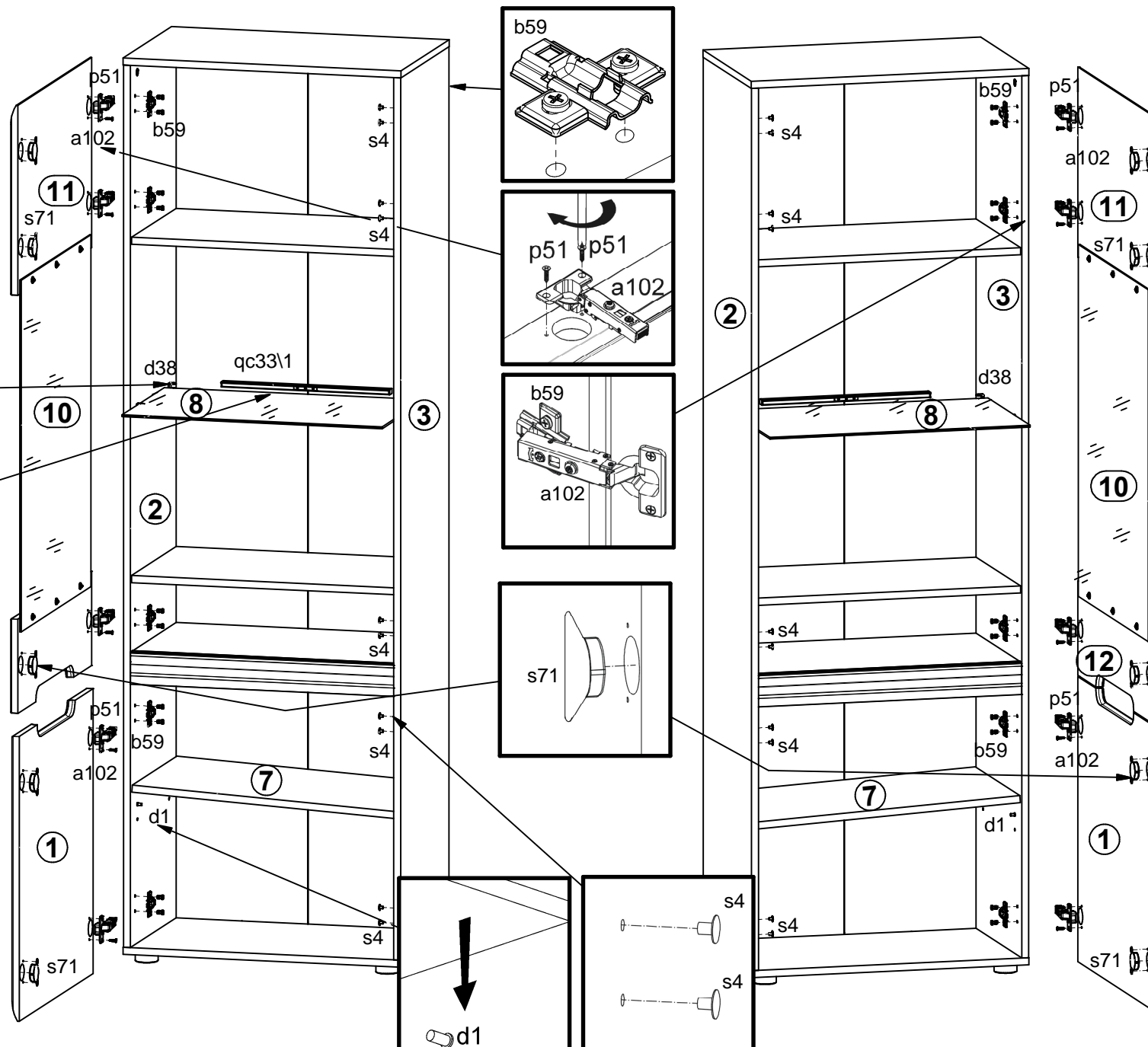
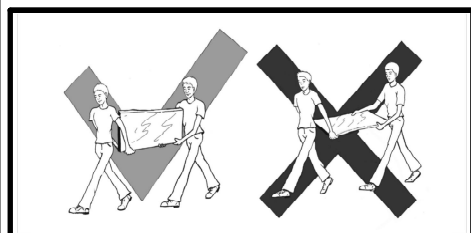
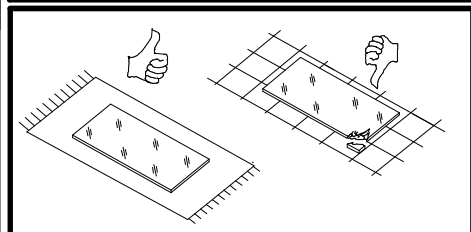
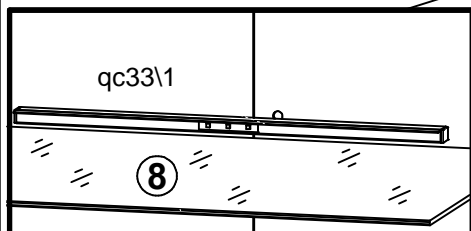
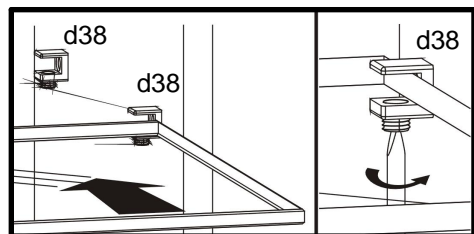
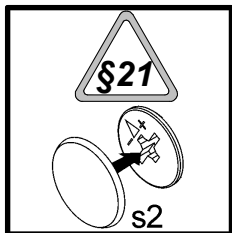
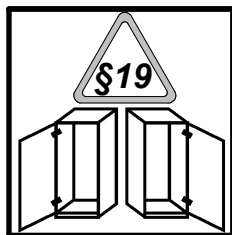

8

