

A	B	C	D
1	S426-3008	1578	220 1/1
2	S426-4016	1580	200 1/1

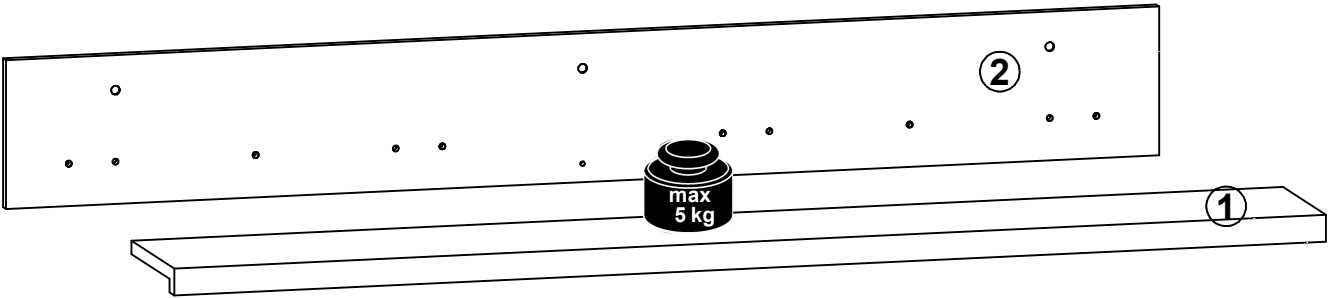

6x Ø7x50 mm e1	6x Ø5x11 mm e4	4x Ø8x30 mm f1	3x Ø10x50 mm f35	1x Ø6x30 mm f50	3x g2	1x Ø4x45 mm p62	3x Ø6x60 mm p75	2x silikon s60
4x Ø 20mm s68	1x 4 mm z1							

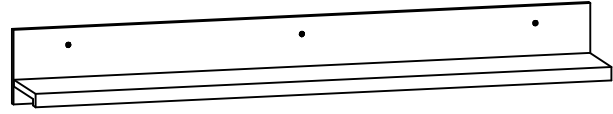
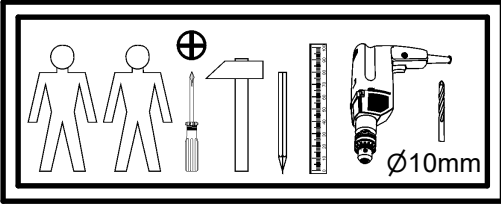
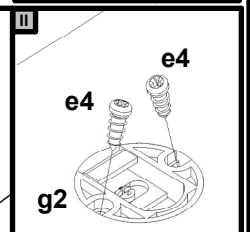
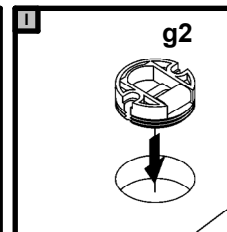
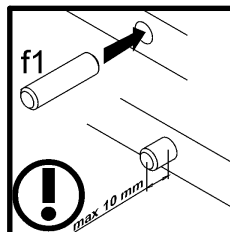
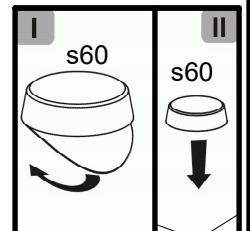
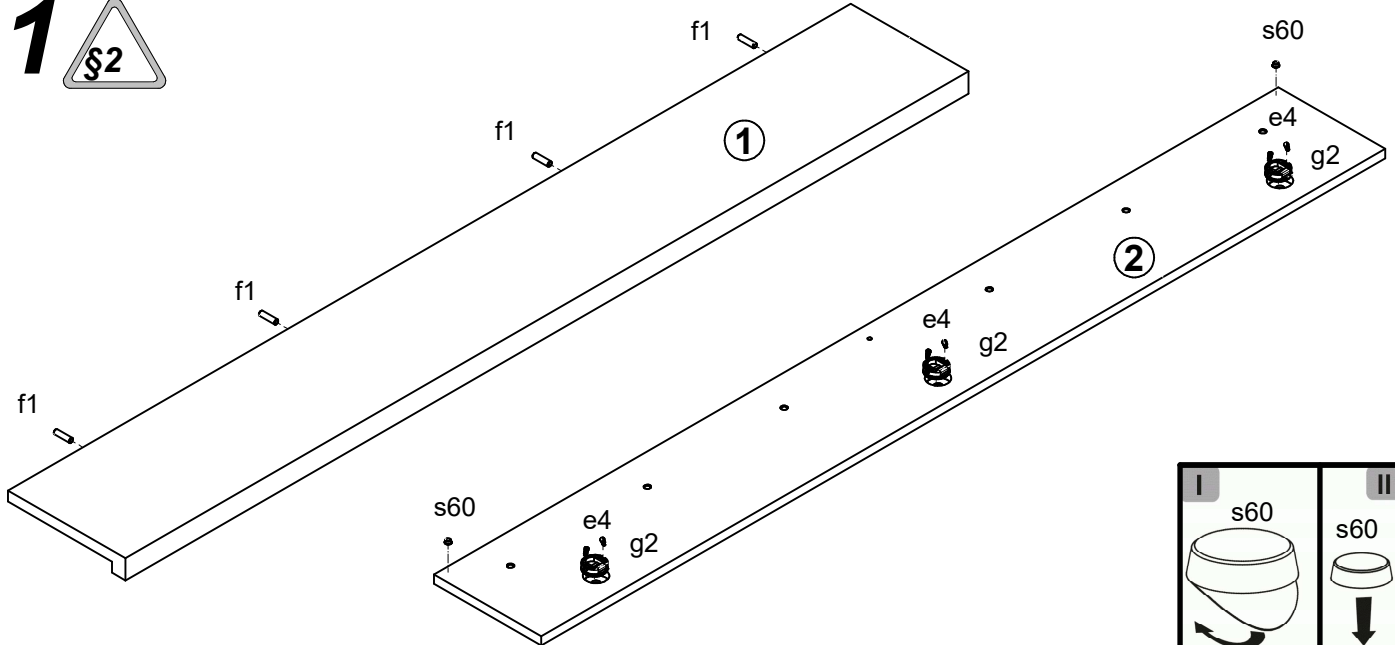

2

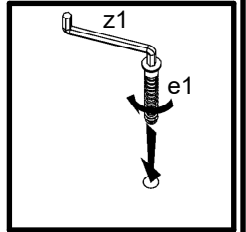
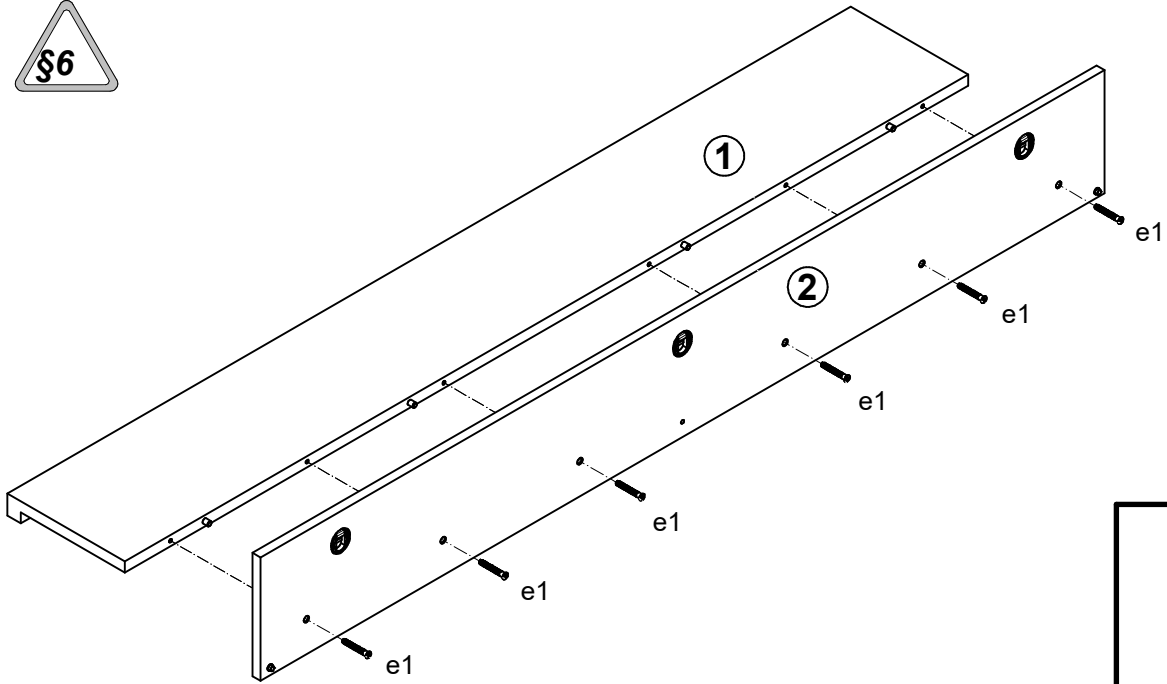

3



φ10 mm

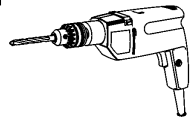

f35

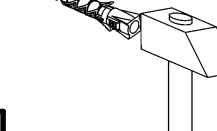

f35

p75

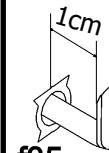

p75

f35

1cm

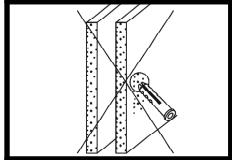
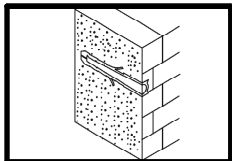

Ø 6 mm

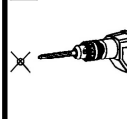

f50

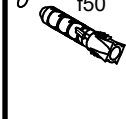

p62



s68



g2



g2



g2

s68

