

- D** Montageanleitung
- NL** Handleiding voor de montage
- TR** Montaj talimatı
- FR** Instructions de montage
- CZ** Montážní návod
- HU** Összeszerelési útmutató
- GB** Assembly instructions
- PL** Instrukcja montażu
- RU** Инструкция по монтажу
- IT** Istruzioni di montaggio
- RO** Instructiuni de asamblare
- SK** Montážny návod

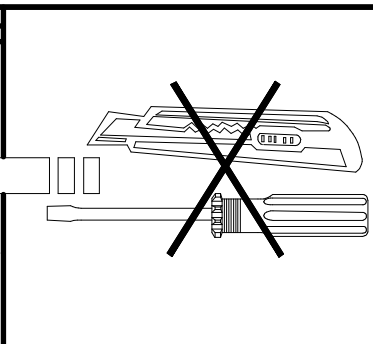
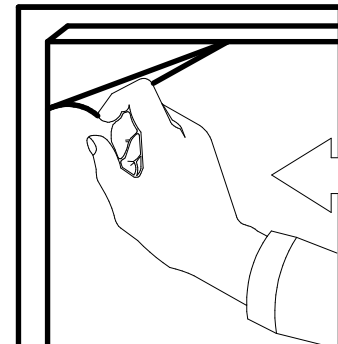
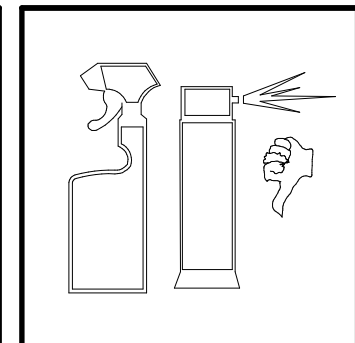
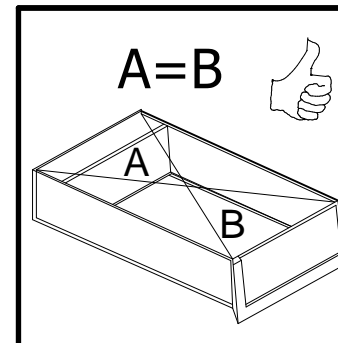
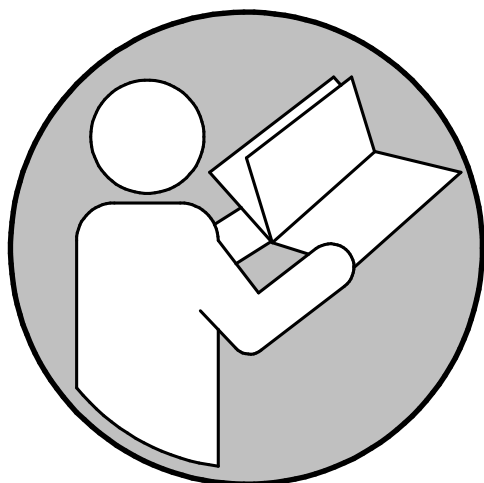
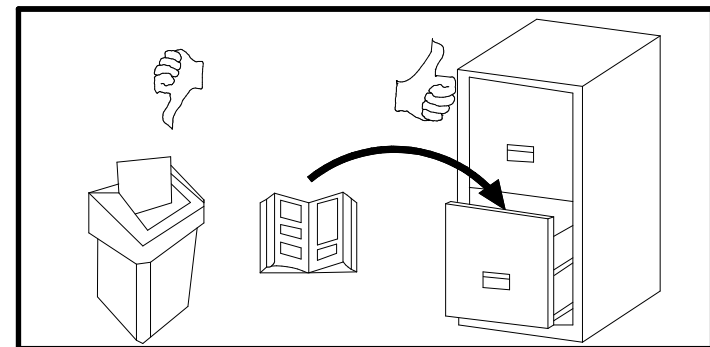
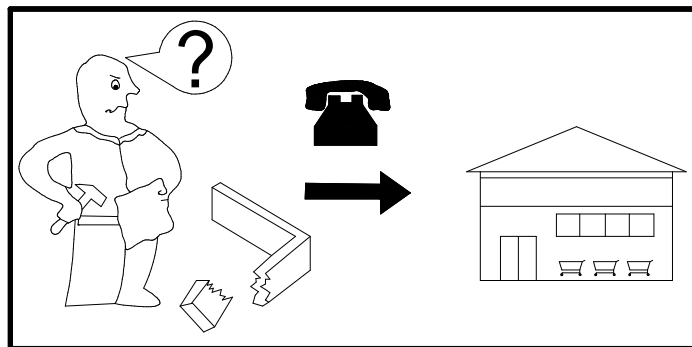
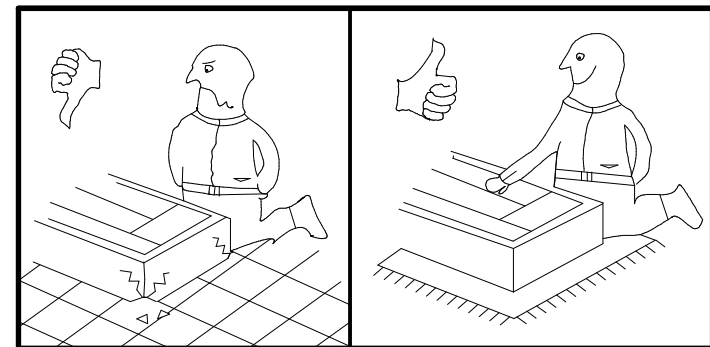
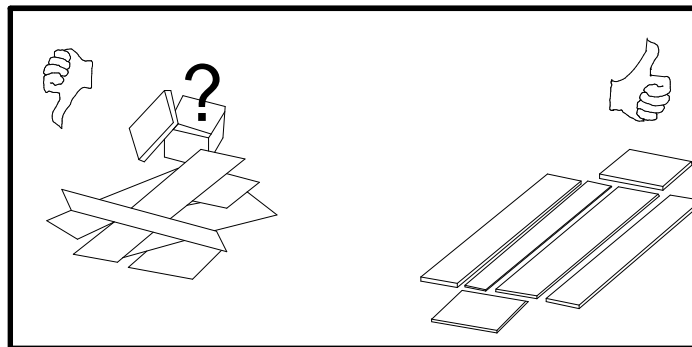
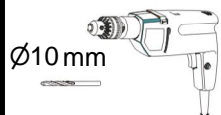
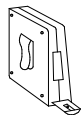
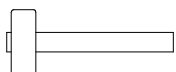
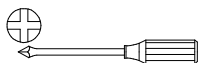
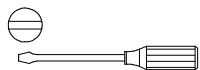
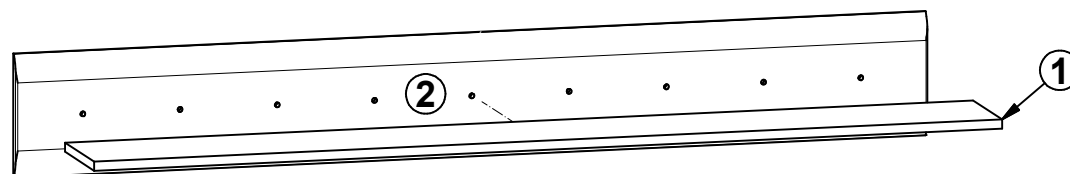
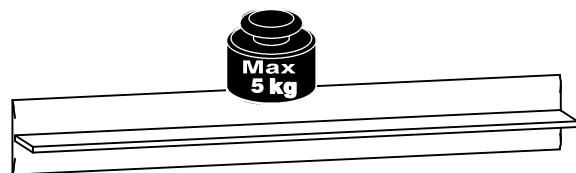
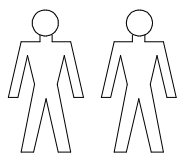
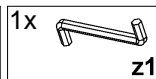
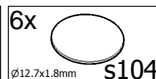
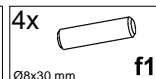
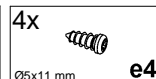
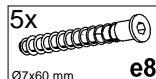
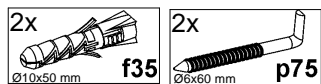

A**S504-P/2/15**

| A | B | C1 | C2 | C3 | D |
|---|-----------|------|------|----|-----|
| 1 | S504-3009 | 1494 | 180 | 15 | 1/1 |
| 2 | S504-4302 | 200 | 1500 | 16 | 1/1 |

**30 min**

A

S504-P/2/15

3 / 4

1 §2

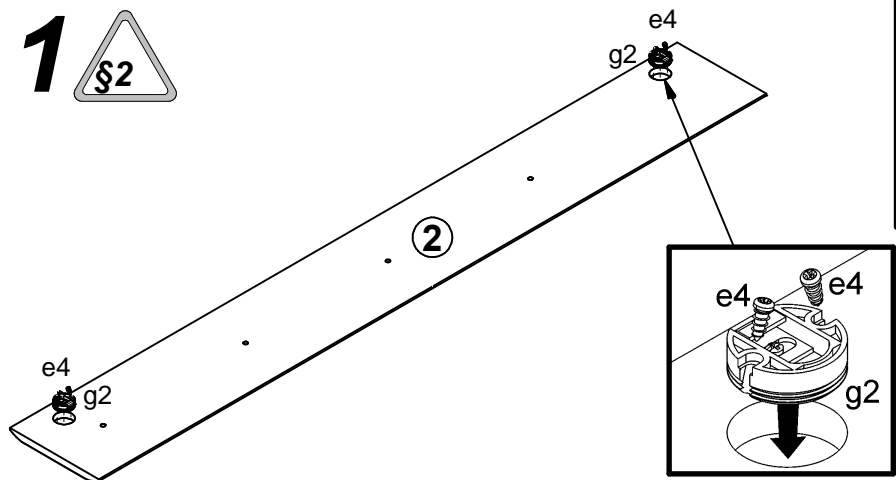

§4

φ10 mm

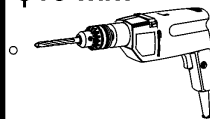

f35

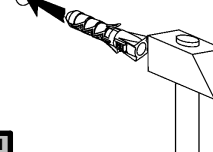

f35



p75

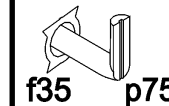

f35 p75

3

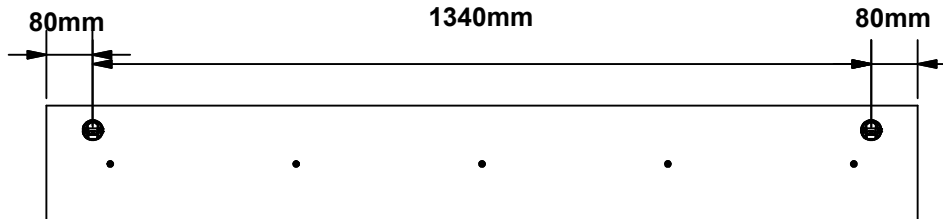

2 §6

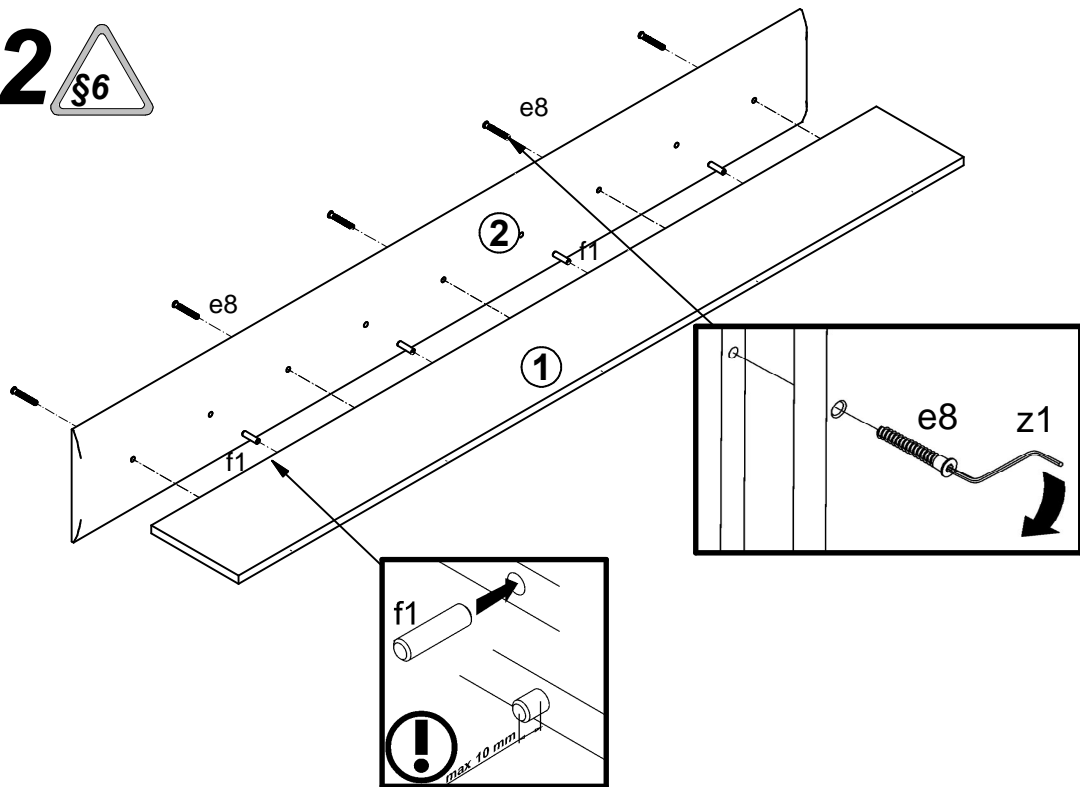

4

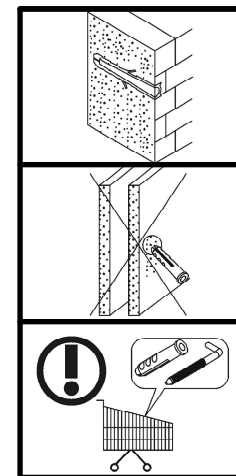
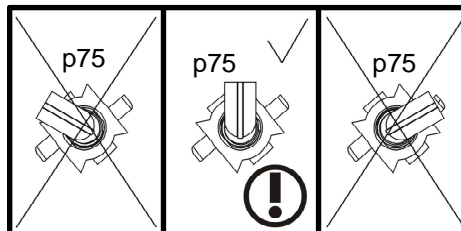
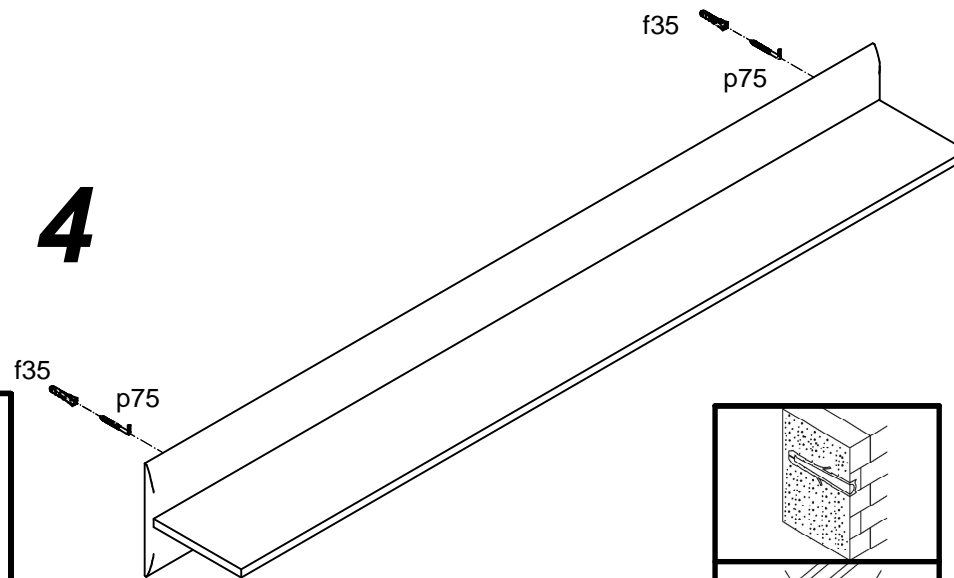

5

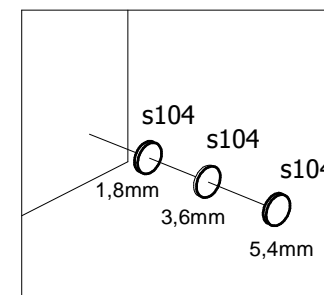
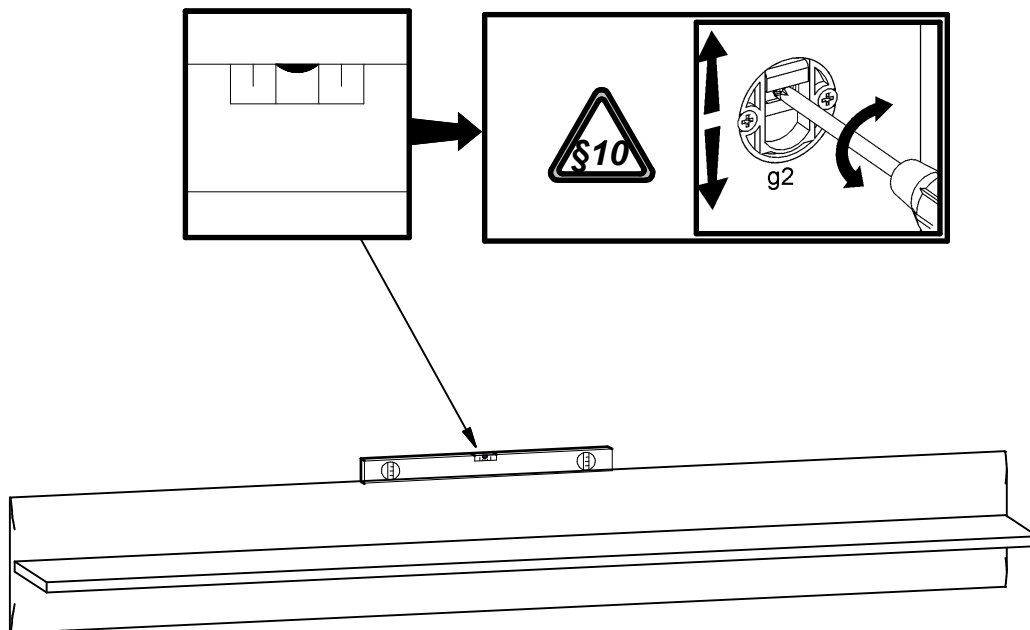
**Pflegehinweis!**

Bitte nur mit einem Staubtuch
(kein Microfasertuch) oder
einem feuchten Lappen reinigen.
KEINE scheuernden Putzmittel
verwenden!

Wskazówka dotycząca pielęgnacji!

Proszę czyścić tylko suchą lub lekko
wilgotną szmatką do kurzu. Nie używać
żadnych środków szorstkich!

