

| A  | B         | C    | D     |
|----|-----------|------|-------|
| 1  | S383-0022 | 1284 | 534   |
| 2  | S383-0023 | 606  | 534   |
| 3  | S383-1037 | 1904 | 385   |
| 4  | S383-1038 | 1904 | 385   |
| 5  | S383-1039 | 1517 | 350   |
| 6  | S383-2025 | 780  | 780   |
| 7  | S383-2026 | 780  | 780   |
| 8  | S383-3016 | 749  | 764,5 |
| 9  | S383-3017 | 310  | 349   |
| 10 | S383-3018 | 309  | 349   |
| 11 | S383-4009 | 1904 | 764,5 |
| 12 | S383-9012 | 1929 | 775   |
| 13 | dr-418    | 418, | 22    |

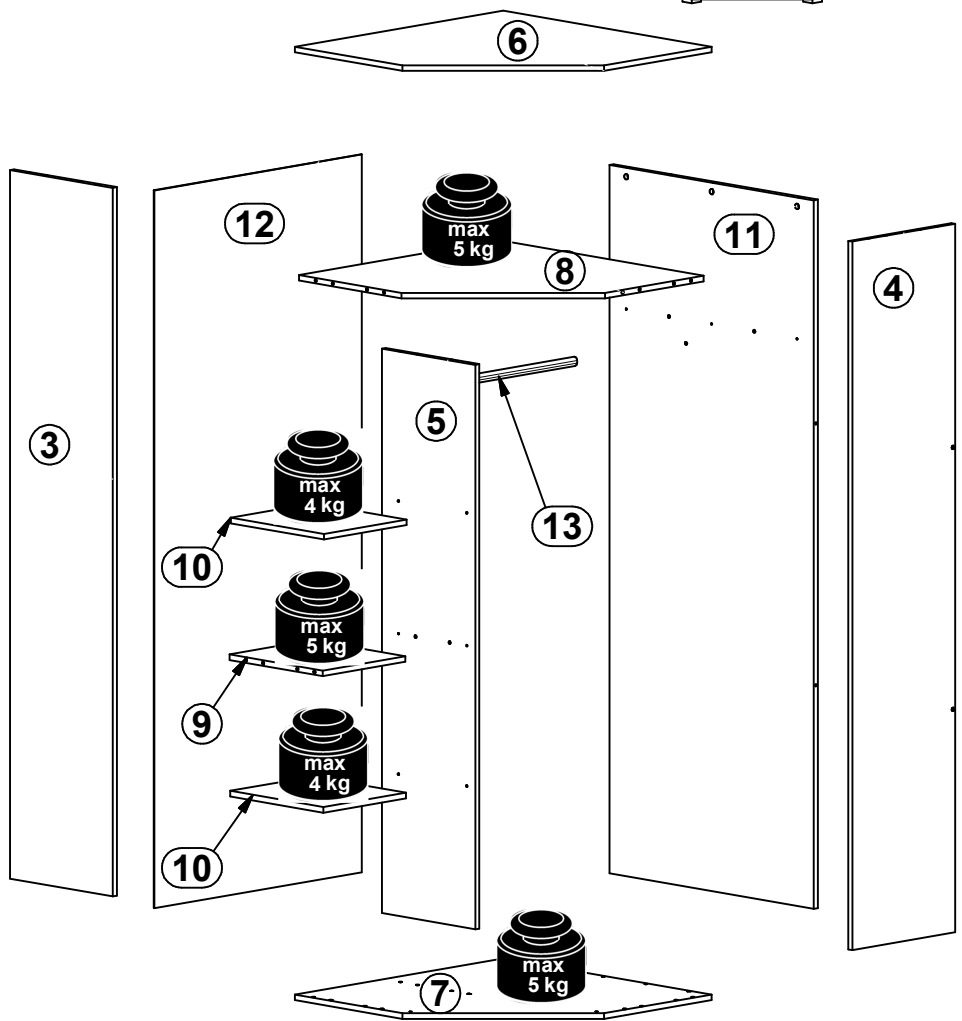

|                            |                        |                     |           |                      |           |           |            |             |
|----------------------------|------------------------|---------------------|-----------|----------------------|-----------|-----------|------------|-------------|
| 5x<br>a10                  | 5x<br>b3               | 1x<br>128mm<br>c409 | 8x<br>d1  | 11x<br>e1            | 10x<br>e2 | 10x<br>e3 | 26x<br>f1  | 5x<br>k82\1 |
| 5x<br>58x58\18 mm<br>k82\2 | 80x<br>1,4x20 mm<br>l1 | 2x<br>h=22mm<br>n1  | 1x<br>n76 | 1x<br>silikon<br>o21 | 2x<br>p1  | 1x<br>d5  | 10x<br>p51 | 6x<br>p93   |
| 20x<br>r1                  | 20x<br>r42             | 2x<br>s1            | 16x<br>s2 | 1x<br>4 mm<br>z1     | 1x<br>n26 | 1x<br>p38 |            |             |

1 §2

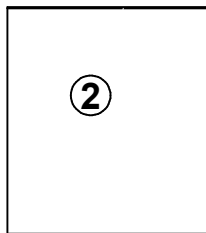
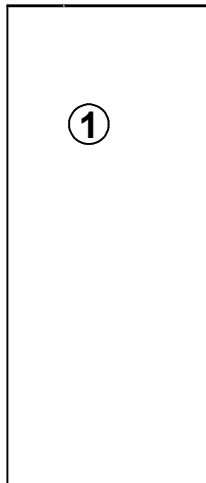
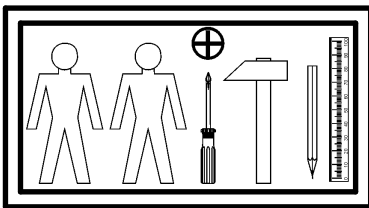
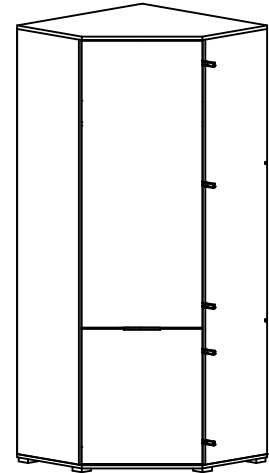
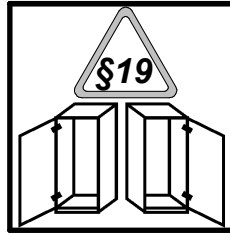
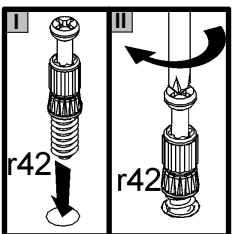
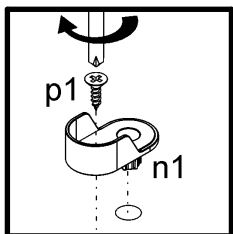
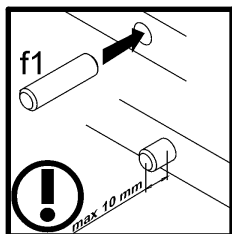
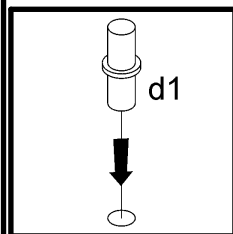
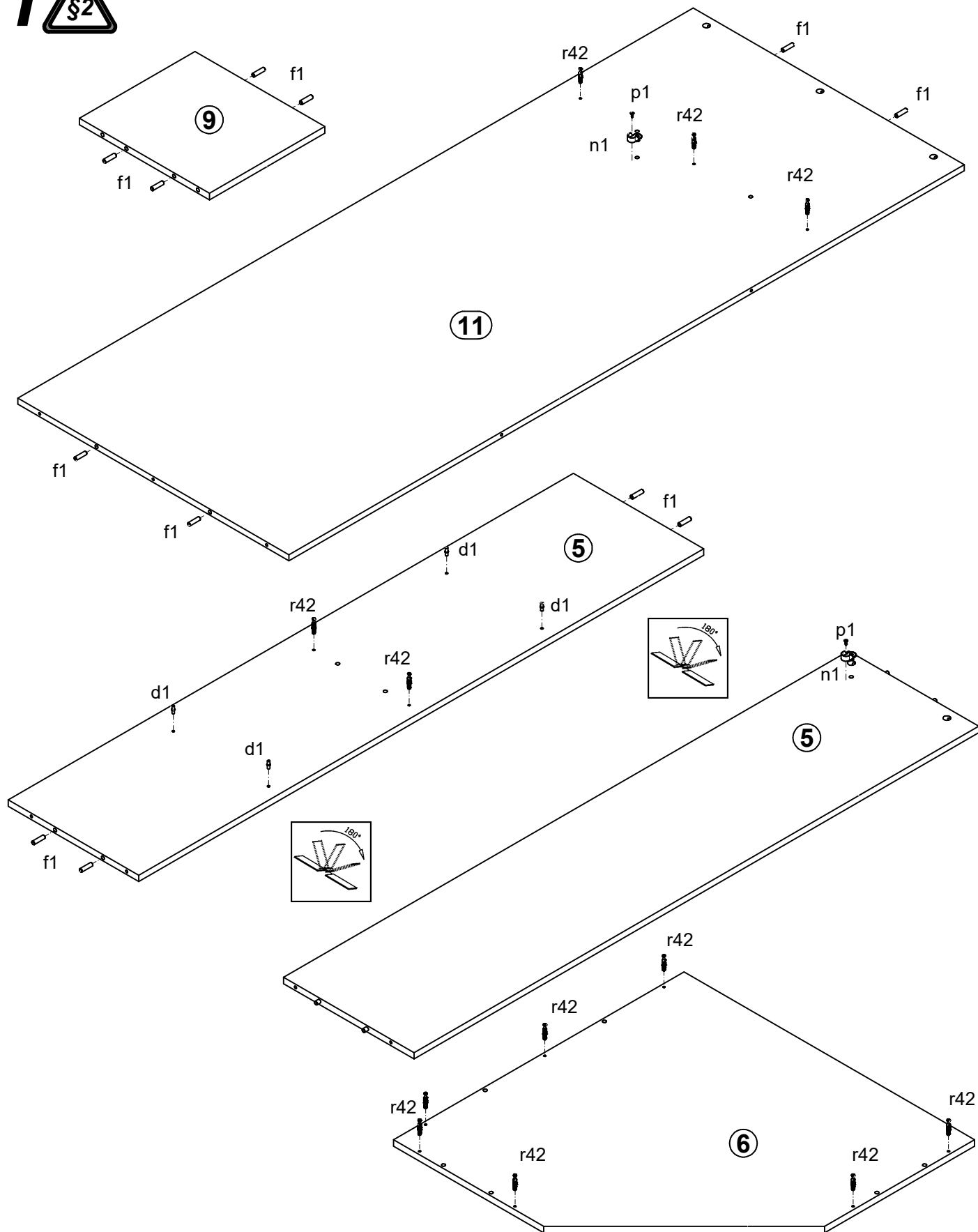

# 2

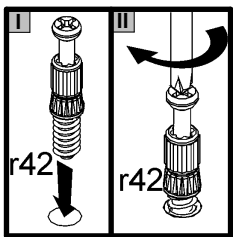
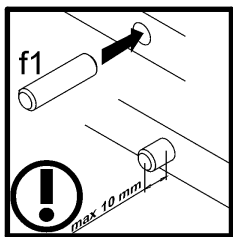
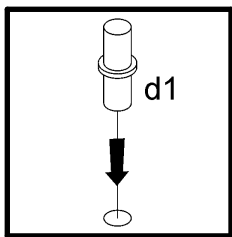
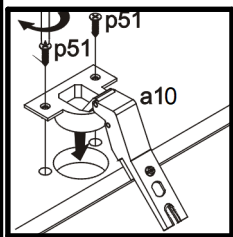
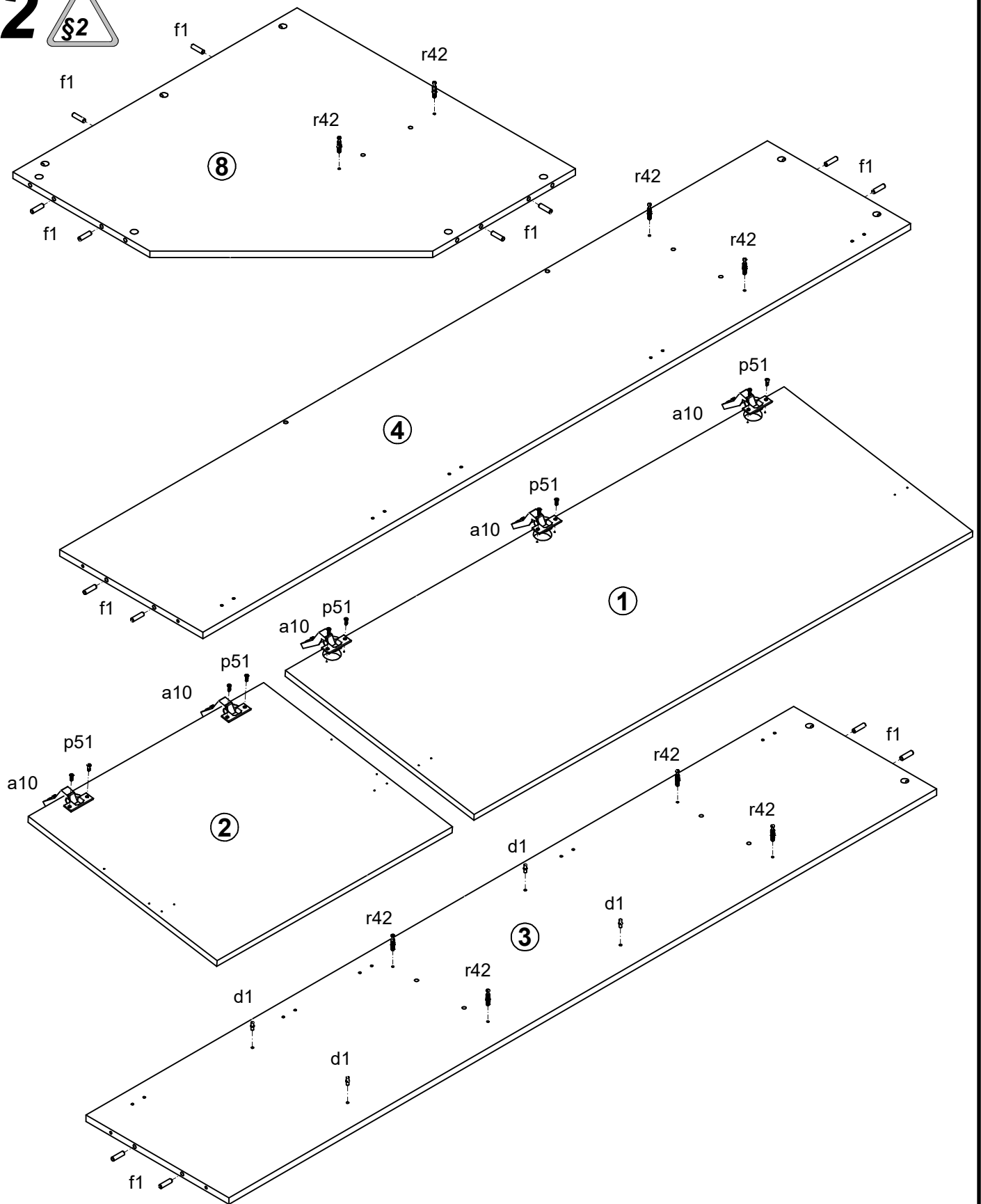

# 3

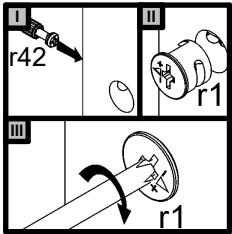
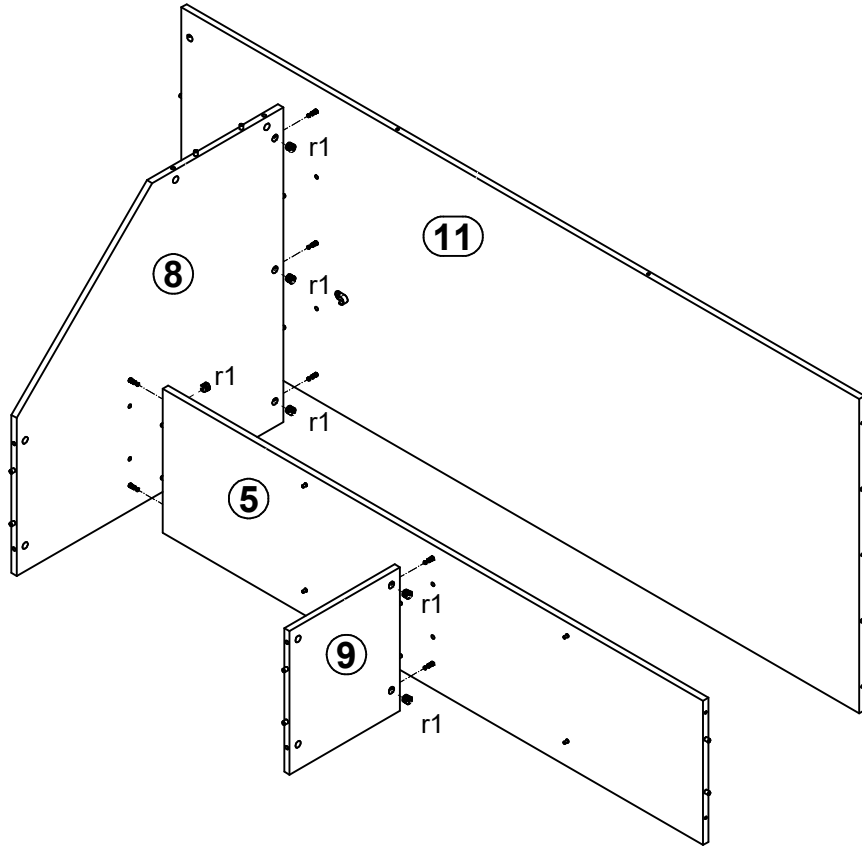

# 4

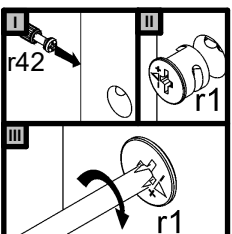
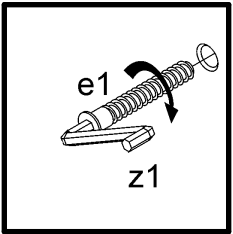
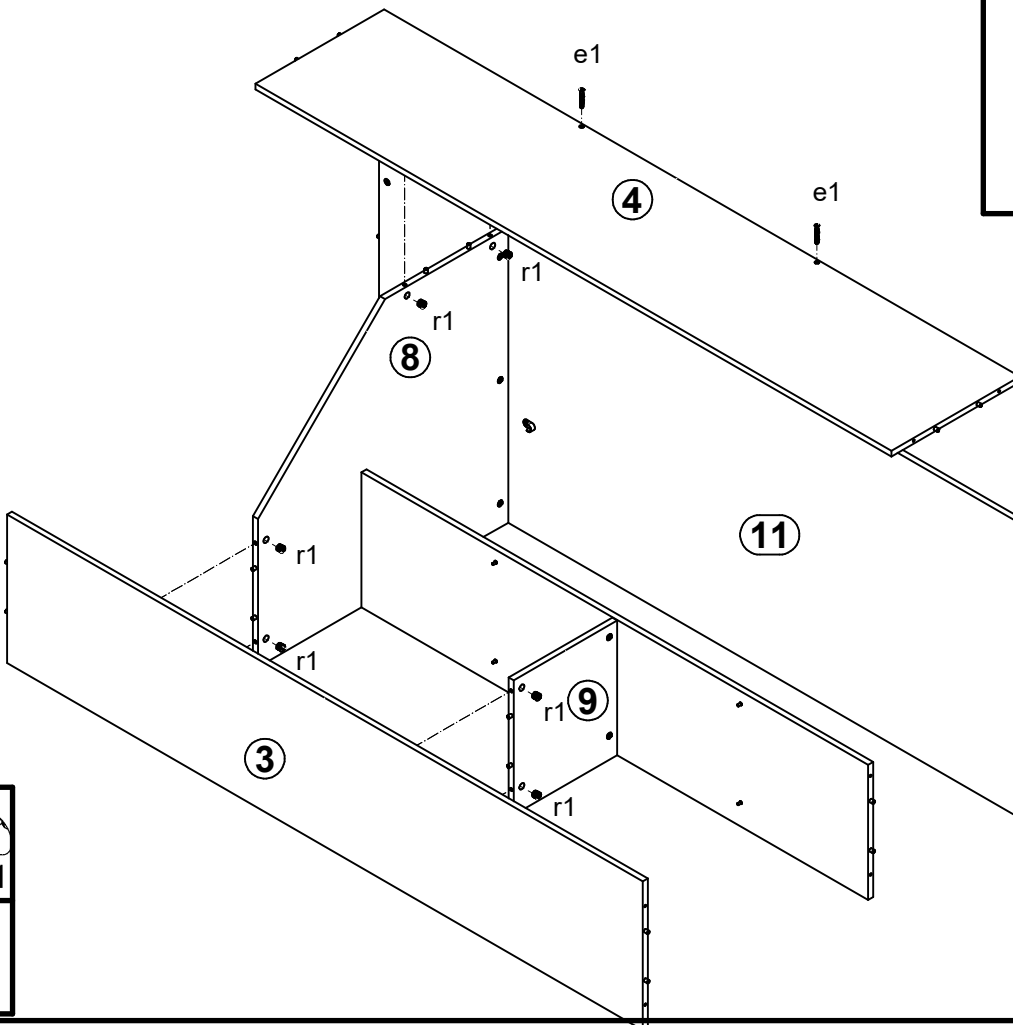

# 5

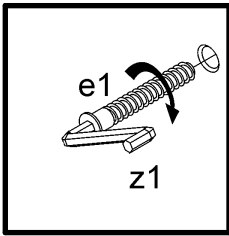
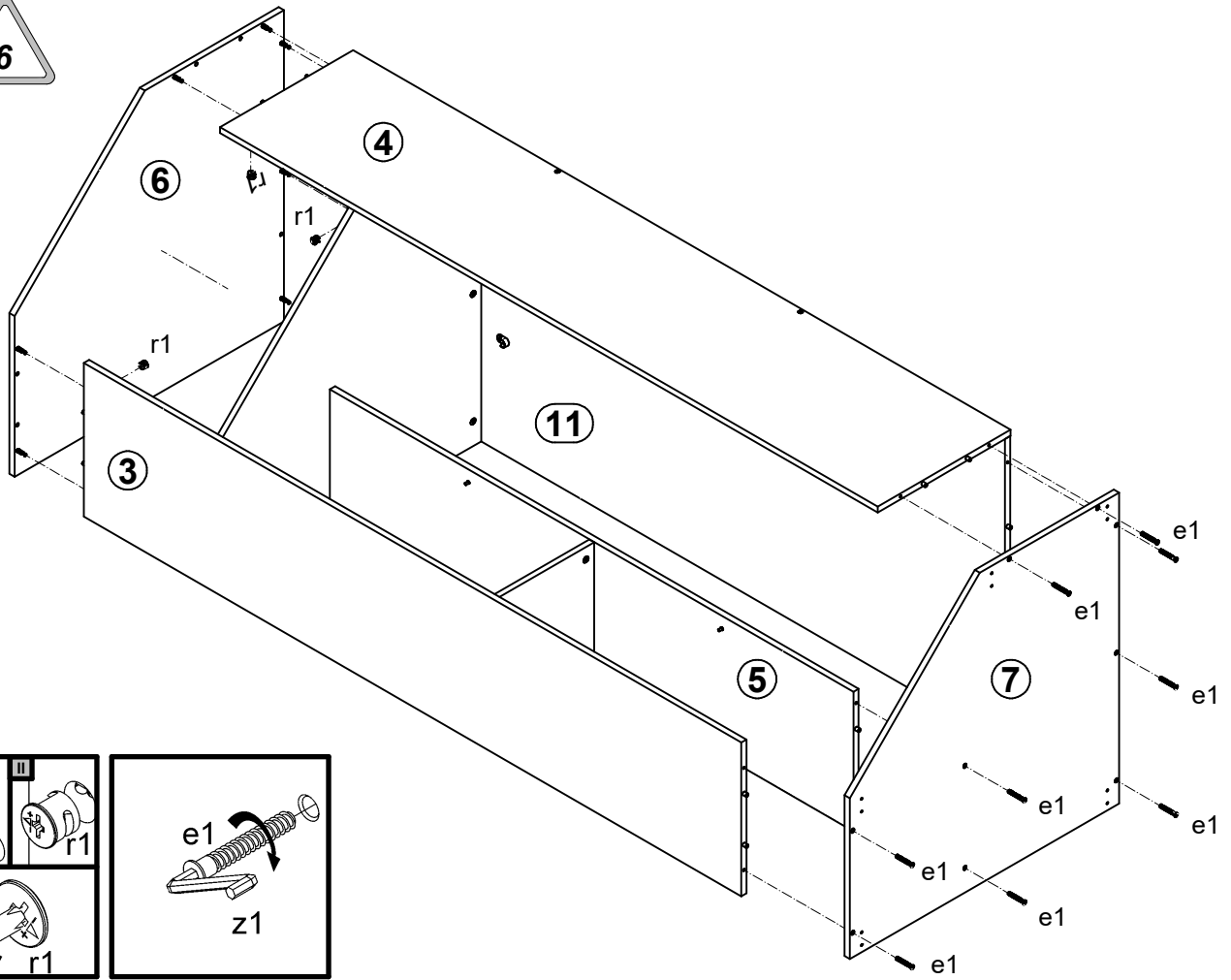

# 6

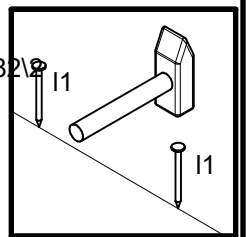
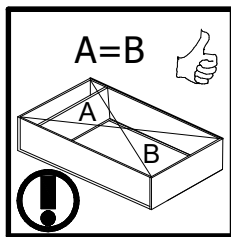
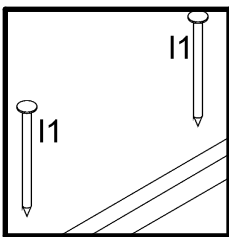
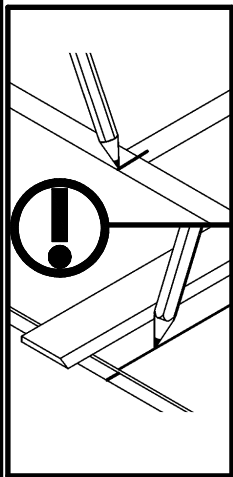
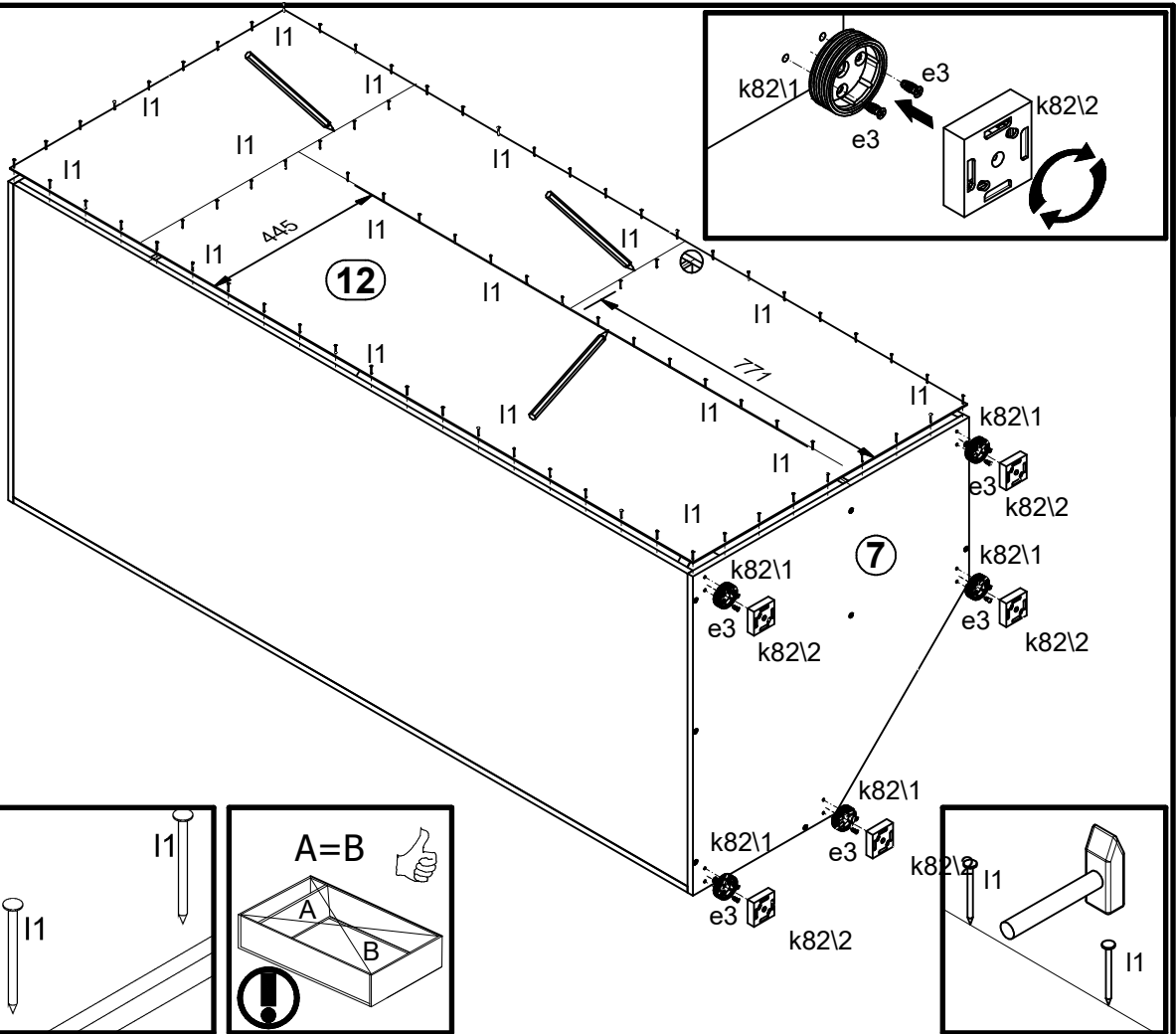

# 7A

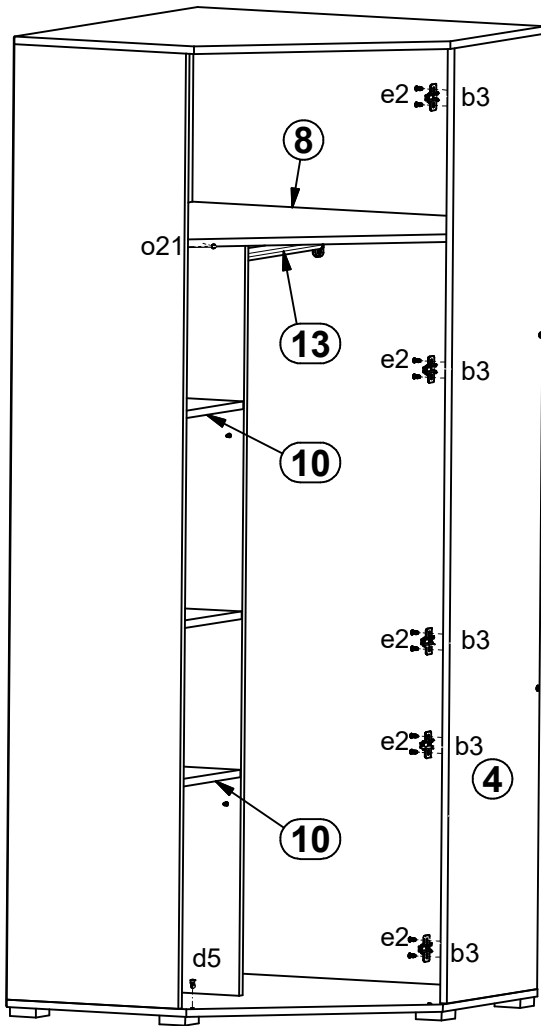

# 7B

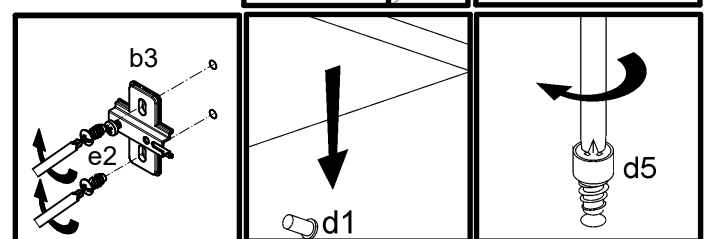
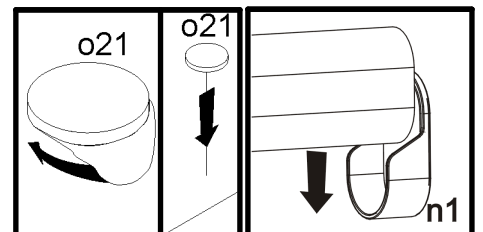
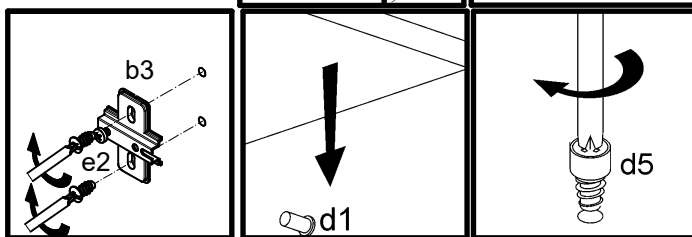
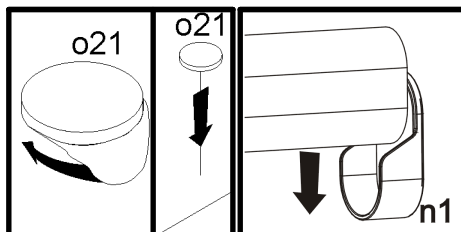
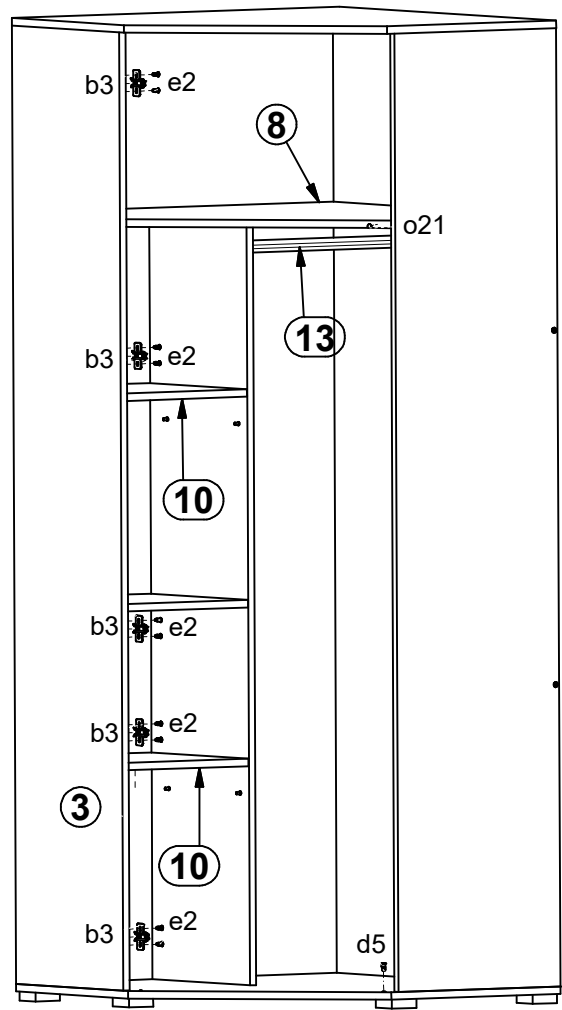

# 8A

# 8B

