

A	B	C	D
1	S455-3001	1370	220
2	S455-4001	1430	165

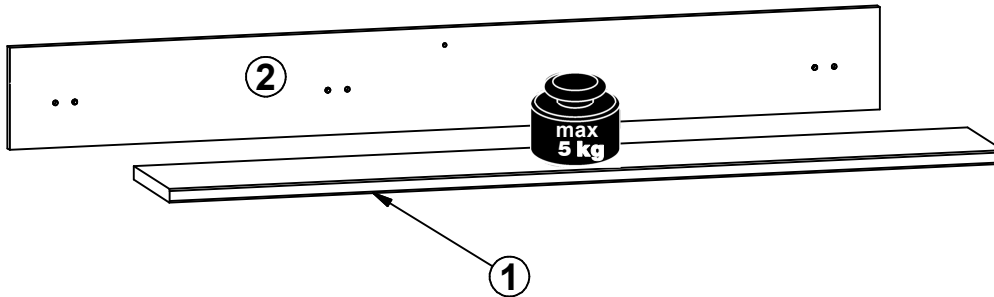

- 4x e1  
Ø7x50 mm
- 4x e4  
Ø5x11 mm
- 4x f1  
Ø8x30 mm
- 2x g2
- 2x f35  
Ø10x50 mm
- 2x p75  
Ø6x60 mm
- 1x f50  
Ø6x30 mm
- 1x p62  
Ø4x45 mm
- 1x s59  
Ø14x0.5 mm

- 2x s60  
silikon
- 1x z1  
4 mm

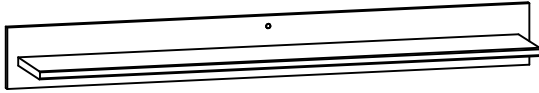
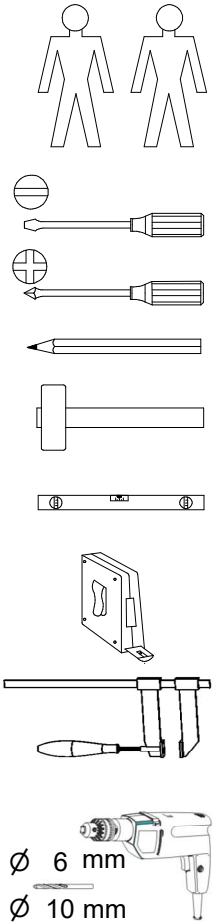
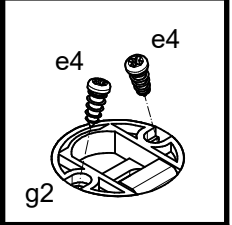
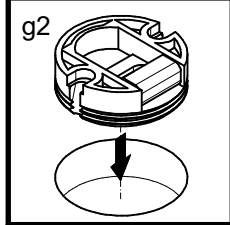
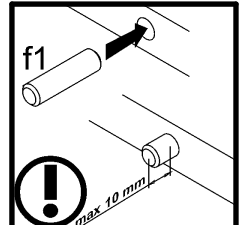
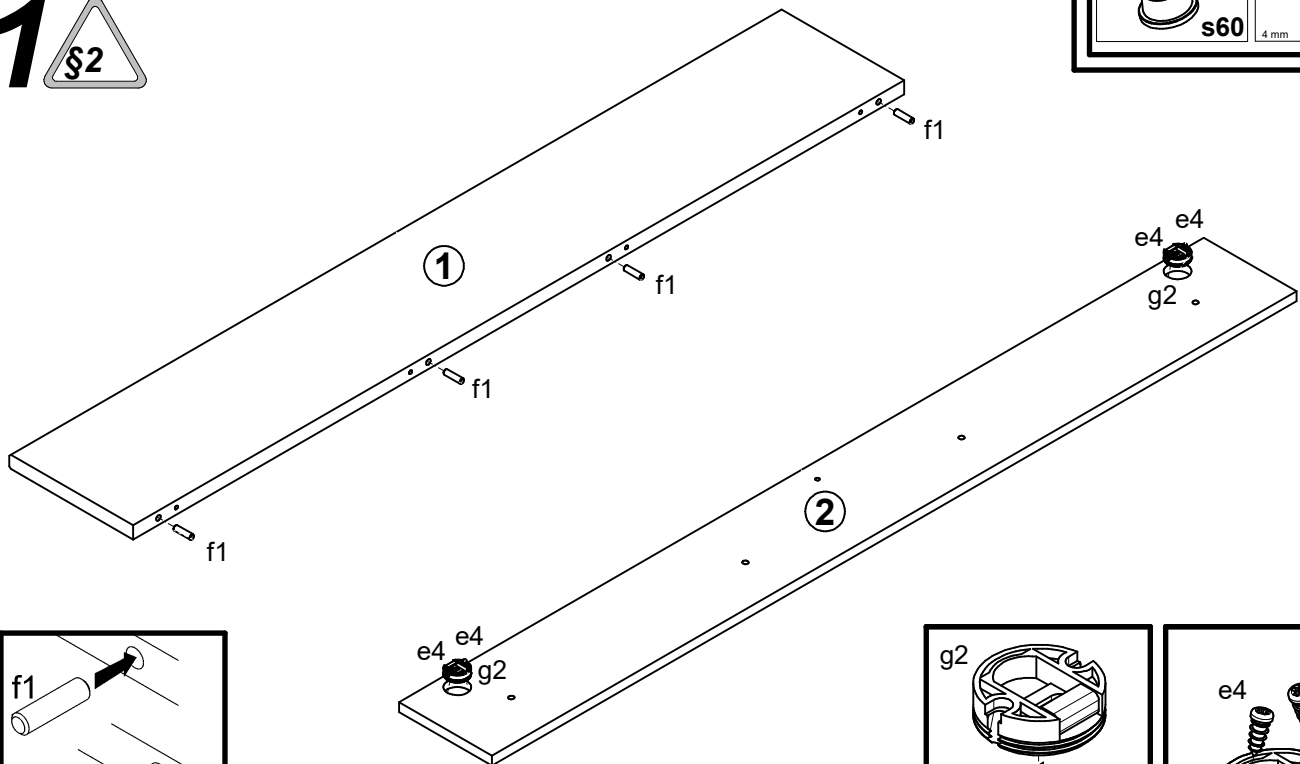

**2** §6

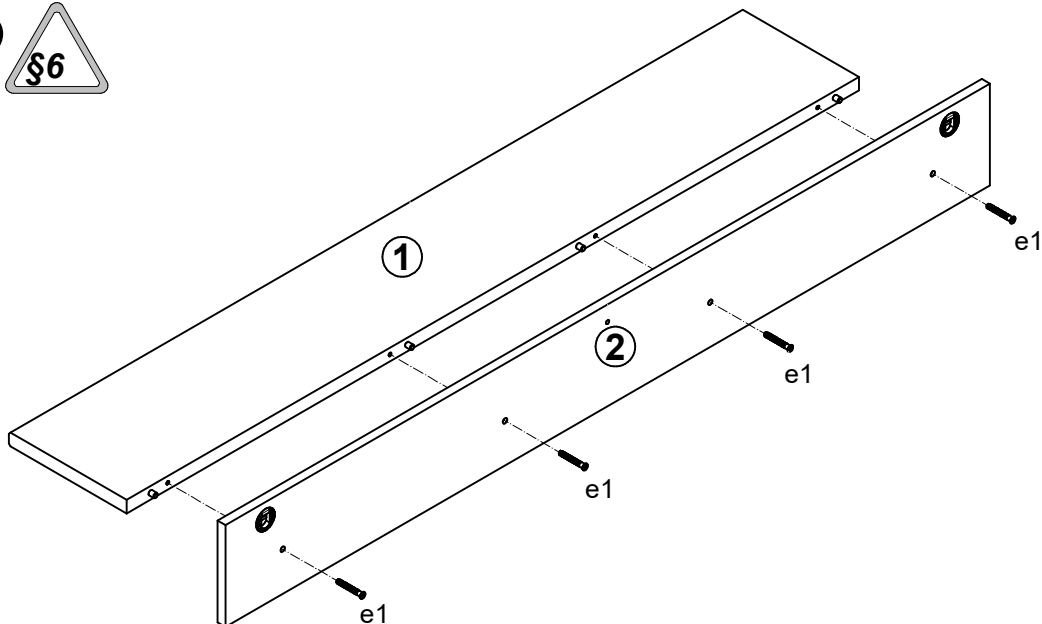

**3** §6



φ10 mm

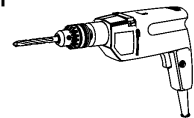

f35

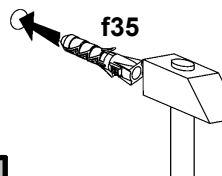

f35

p75

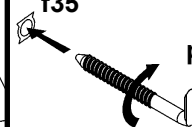

1cm

p75

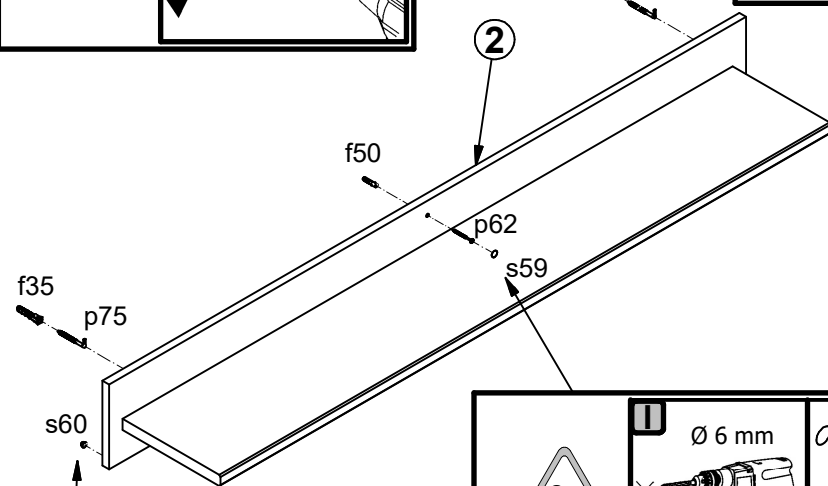
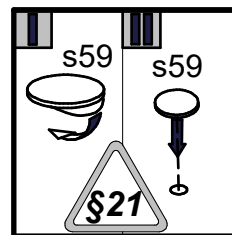
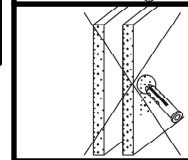
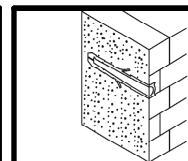
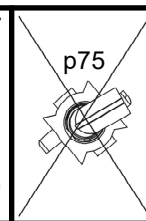
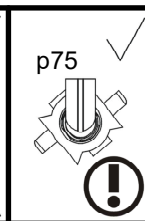
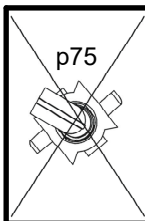
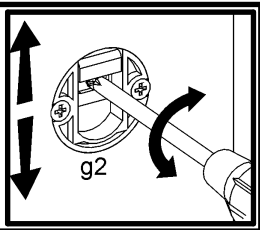
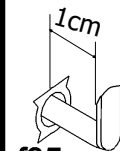

Ø 6 mm

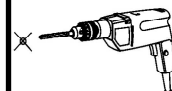

f50

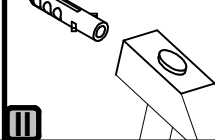

p62

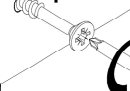

s59

