

A

ZELE

S383-KOM2D3S

A	B	C	D	
1	S383-0005	446	264	3/3
2	S383-0006	804	446	3/3
3	S383-1005	815	385	1/3
4	S383-1006	815	385	1/3
5	S383-1009	815	385	1/3
6	S383-1010	815	385	1/3
7	S383-2005	1350	403	2/3
8	S383-2006	1350	403	2/3
9	S383-3003	427	380	2/3
10	S383-9003	395	348	2/3
11	S383-9004	840	448	1/3
12	ZS4-5503	385	140	2/3
13	ZS6-501	350	140	1/3
14	ZS6-502	350	140	1/3

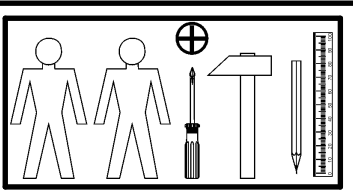
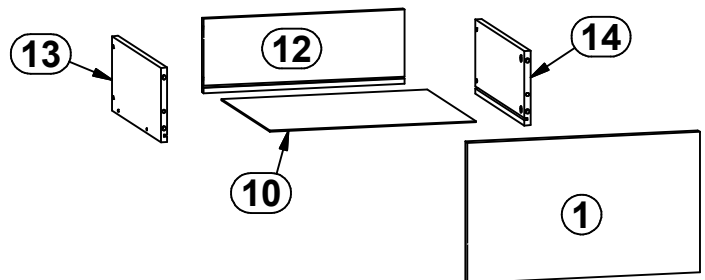
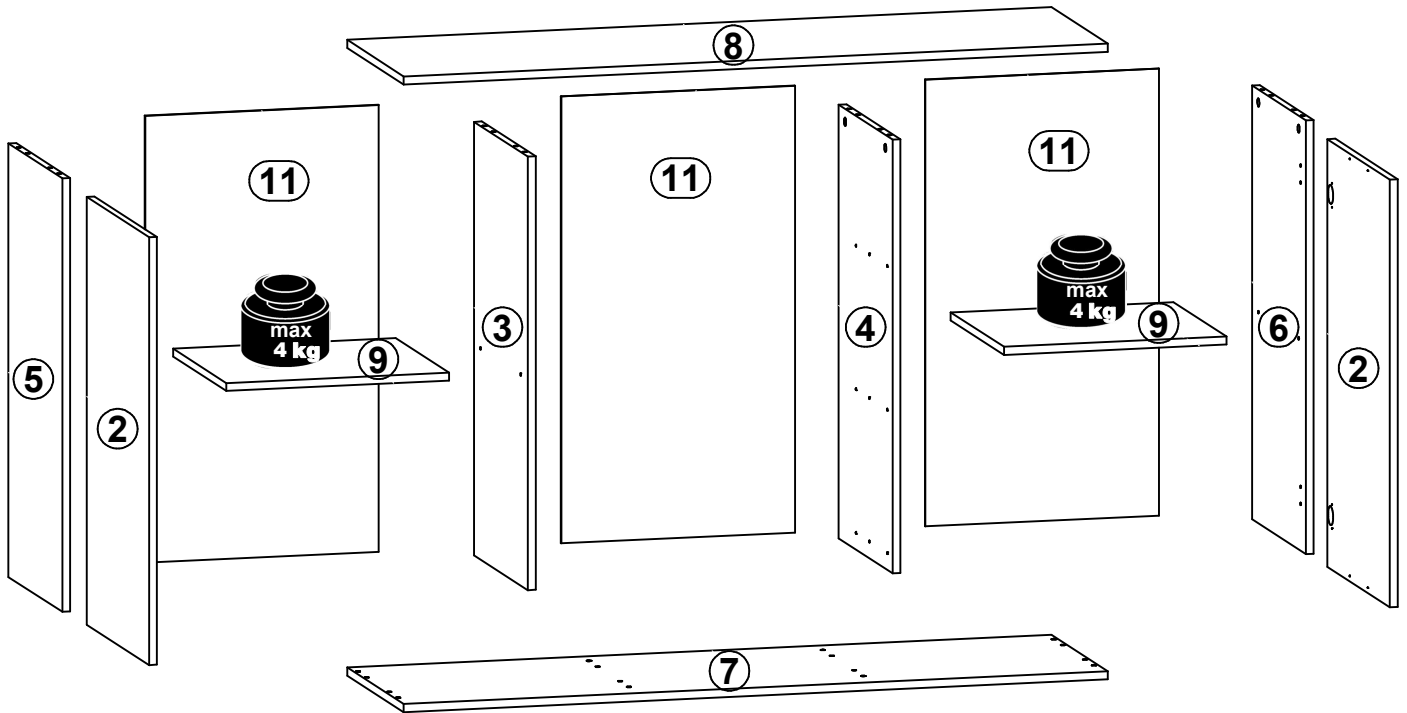
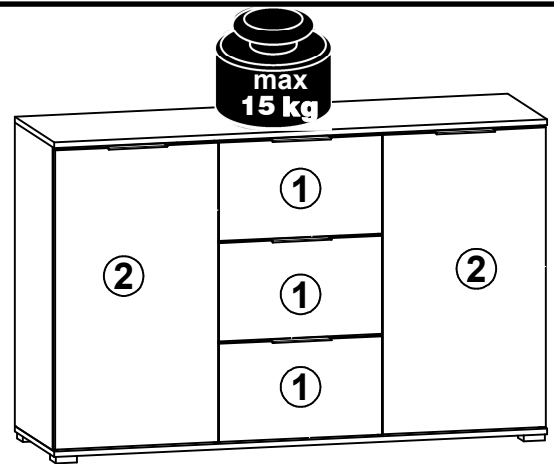

4x a44	4x b19	5x c409 128mm	8x d1 Ø5x17 mm	8x e1 Ø7x50 mm	12x e19 Ø5x9 mm	30x e3 Ø6x13 mm	16x f1 Ø8x30 mm	12x f25 Ø6,5x40 mm
6x f9 Ø6x30 mm	6x k82\1	6x k82\2	45x l1	10x n108 20x13x3,5\1	10x o21 silikon	8x p51 Ø3,5x15 mm	10x p55 Ø2,9x16 mm	10x p93 Ø4x13 mm
8x r1 Ø15x12 mm #16	12x r15 Ø12x10,5 mm #12	20x r42 20\11	3x w45\CL 350 mm	3x w45\CR 350 mm	3x w45\DL 350 mm	3x w45\DR 350 mm	6x s2 Ø16	1x z1 4 mm
							1x n26\1	1x p38 Ø3,5x16 mm

1

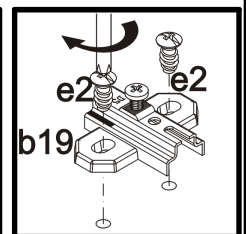
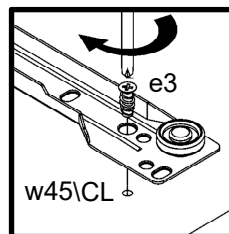
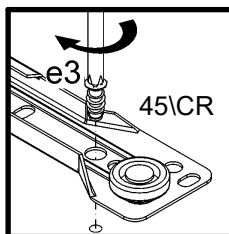
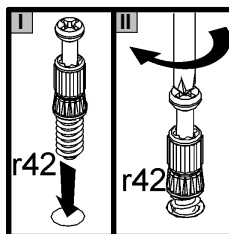
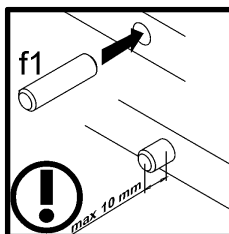
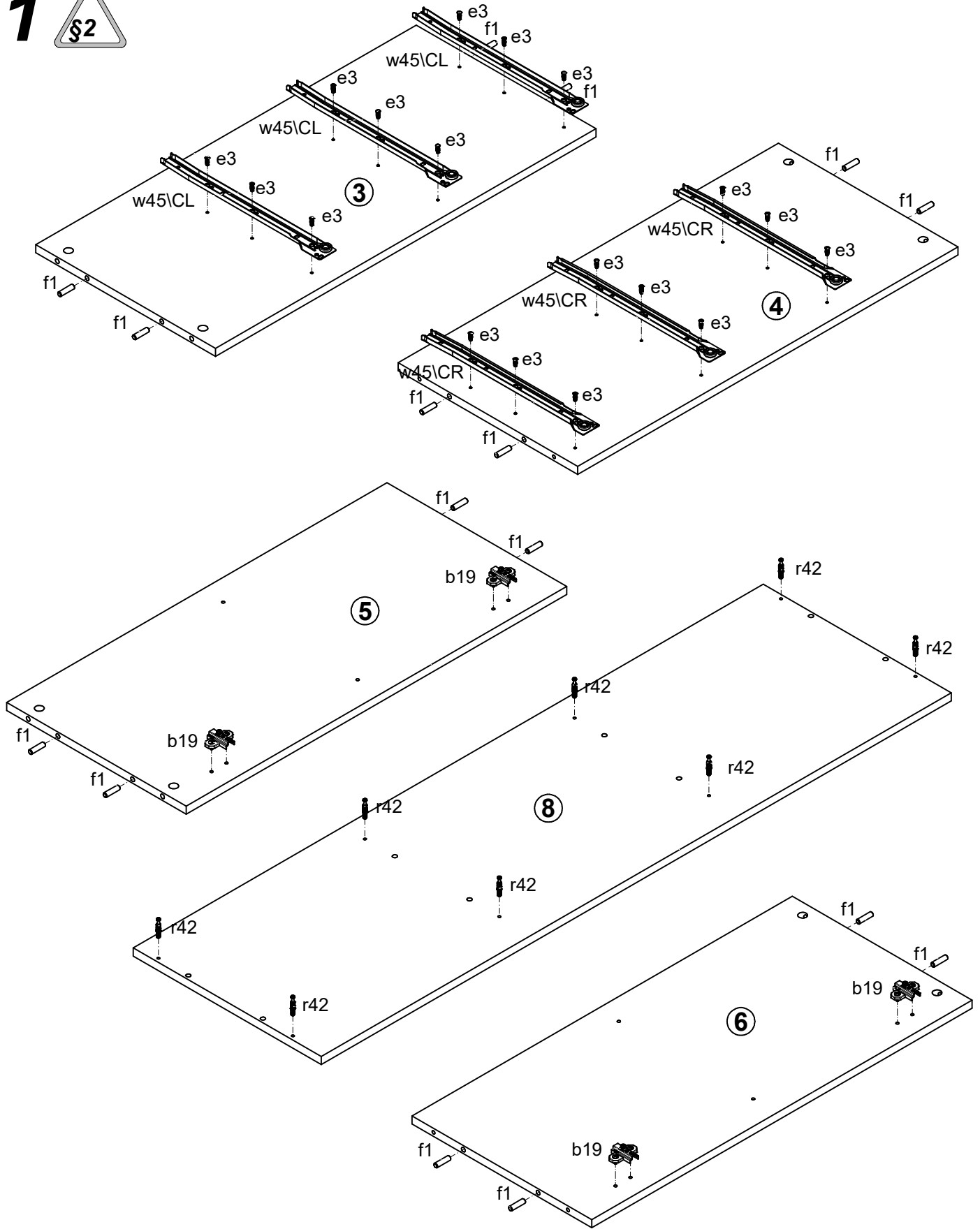

2

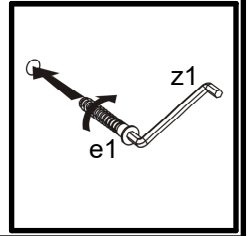
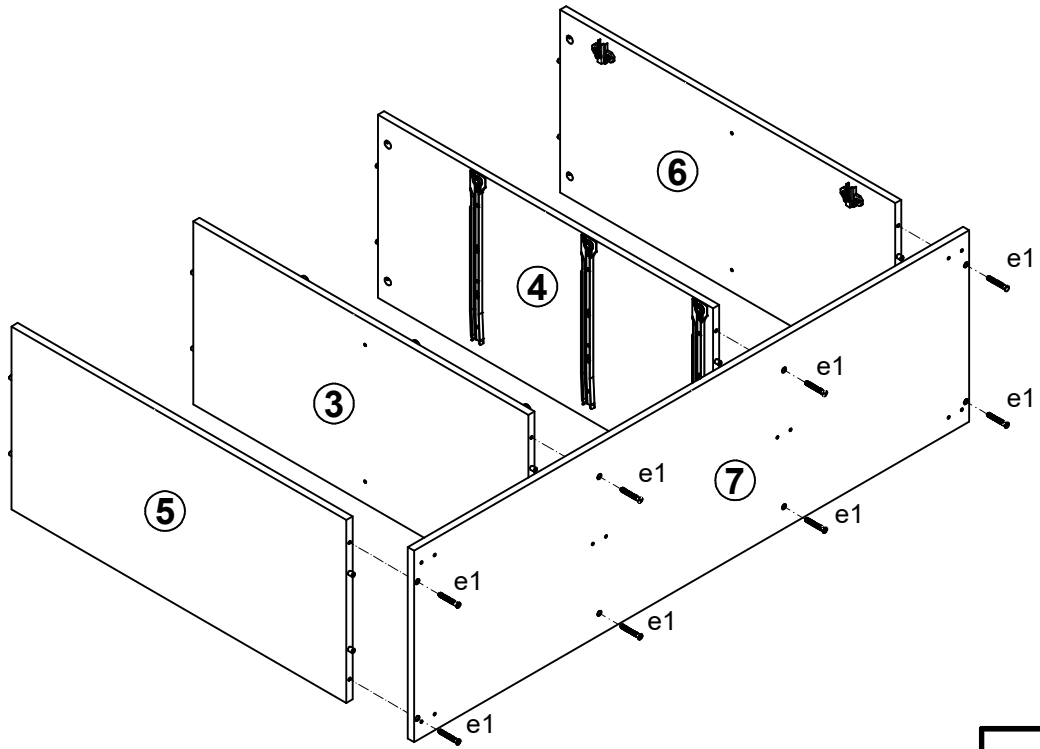

3

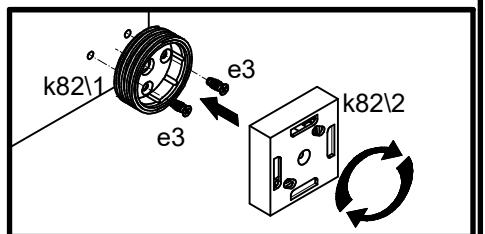
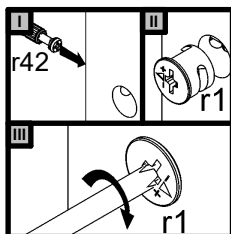
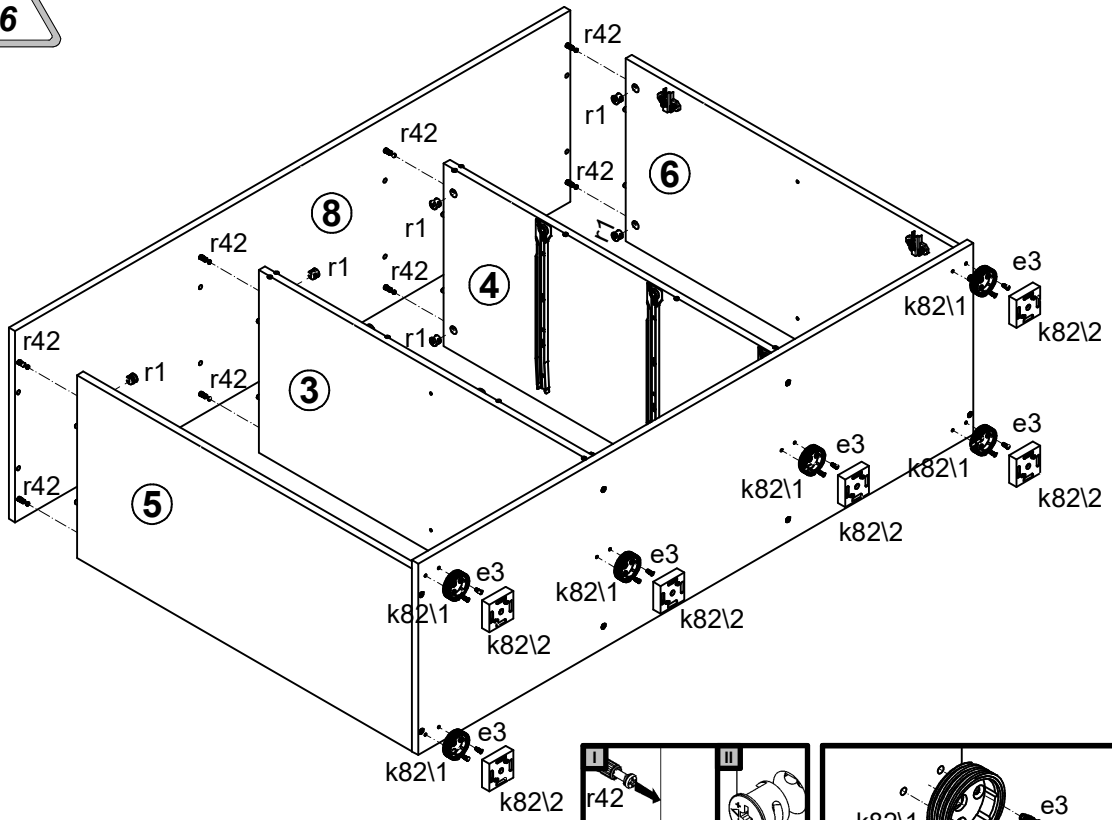

4

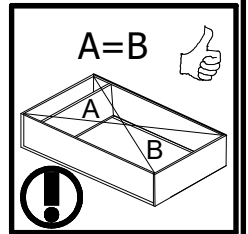
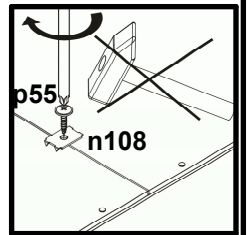
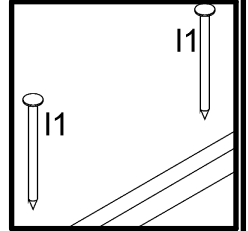
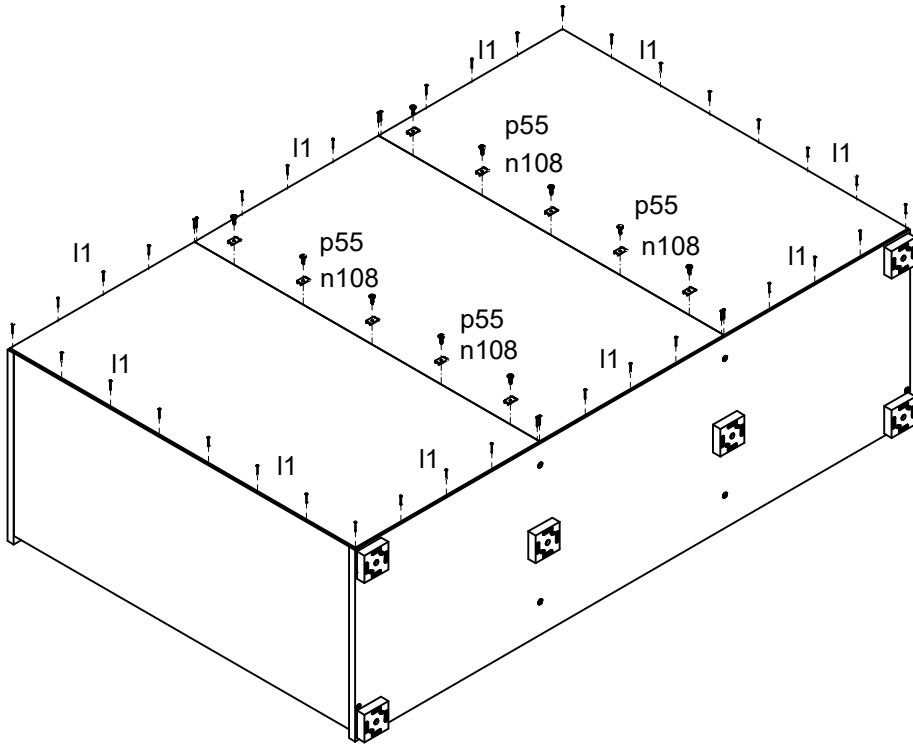

5

