

A	B	C	D	
1	S383-1030	568	220	1/1
2	S383-1031	480	220	1/1
3	S383-1032	598	220	1/1
4	S383-2021	1200	600	1/1
5	S383-2022	1200	600	1/1
6	S383-5006	200	490	1/1
7	S383-5007	200	112	1/1

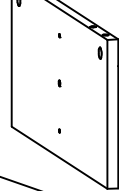

6

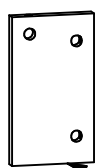
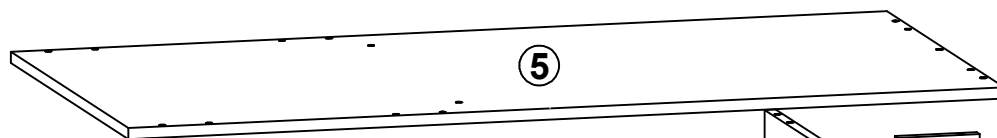
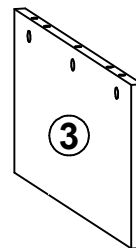
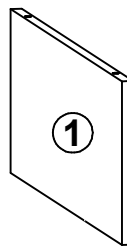
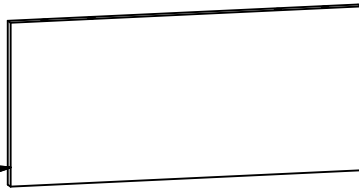
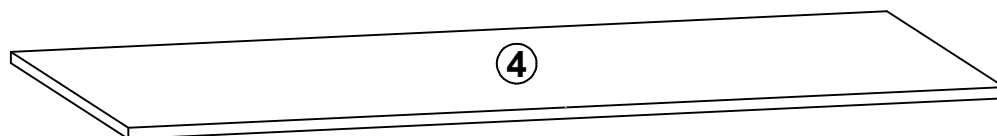
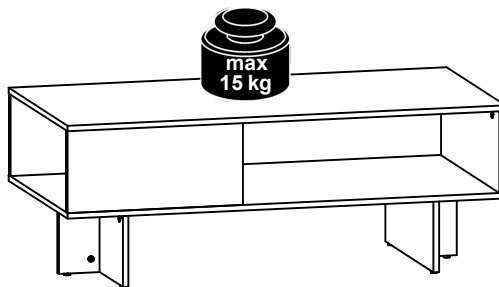
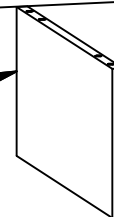

7

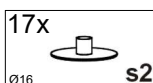
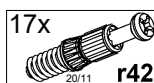
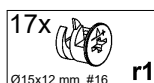
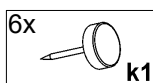
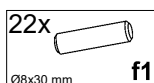
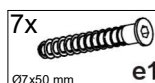
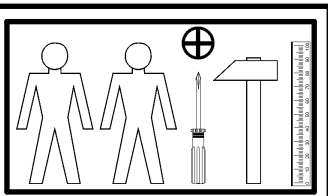

1 

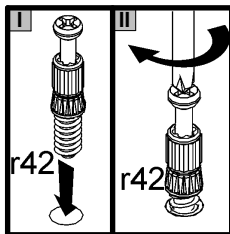
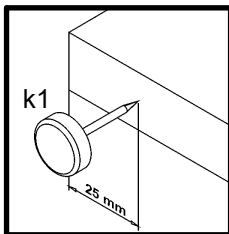
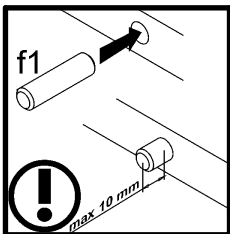
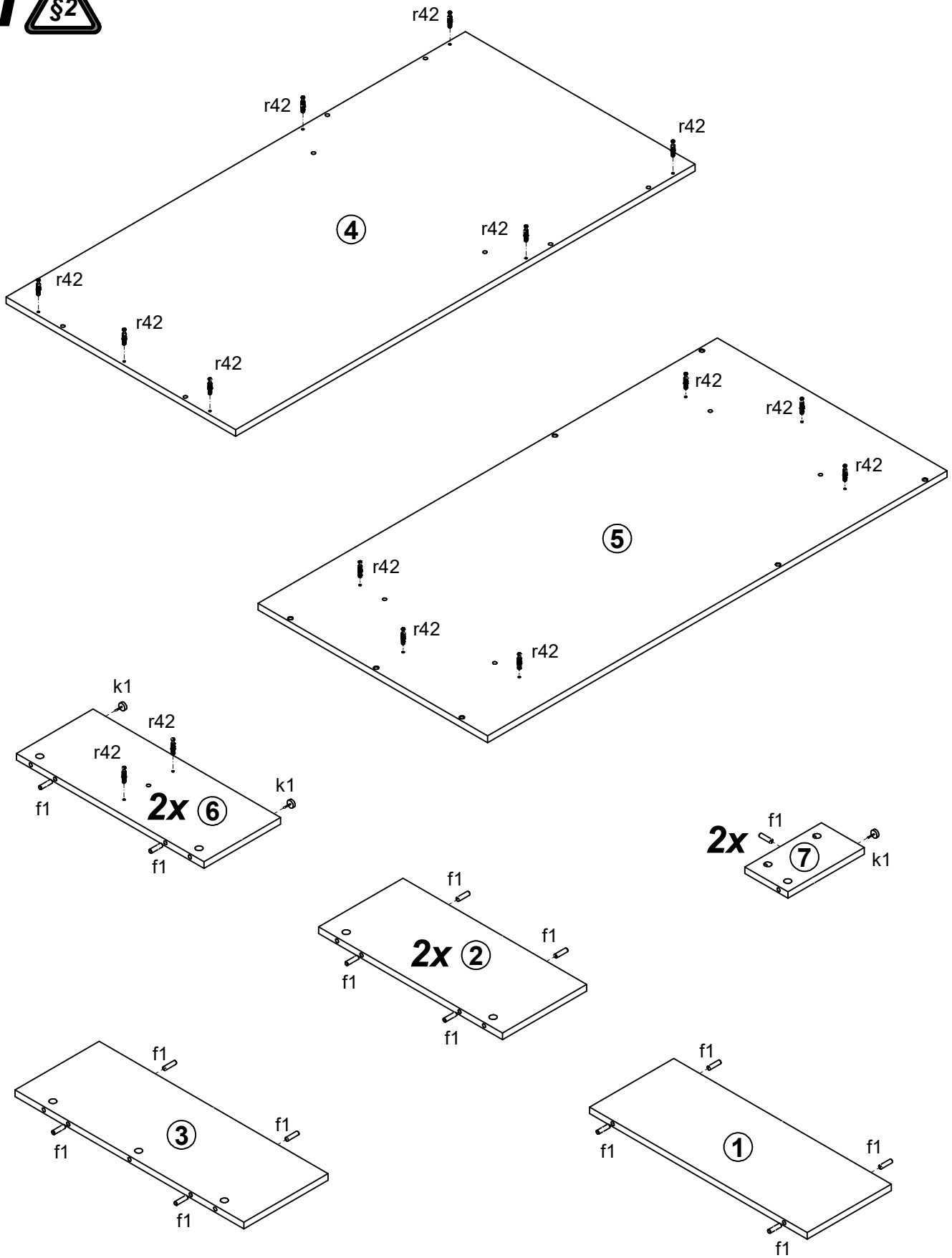

2

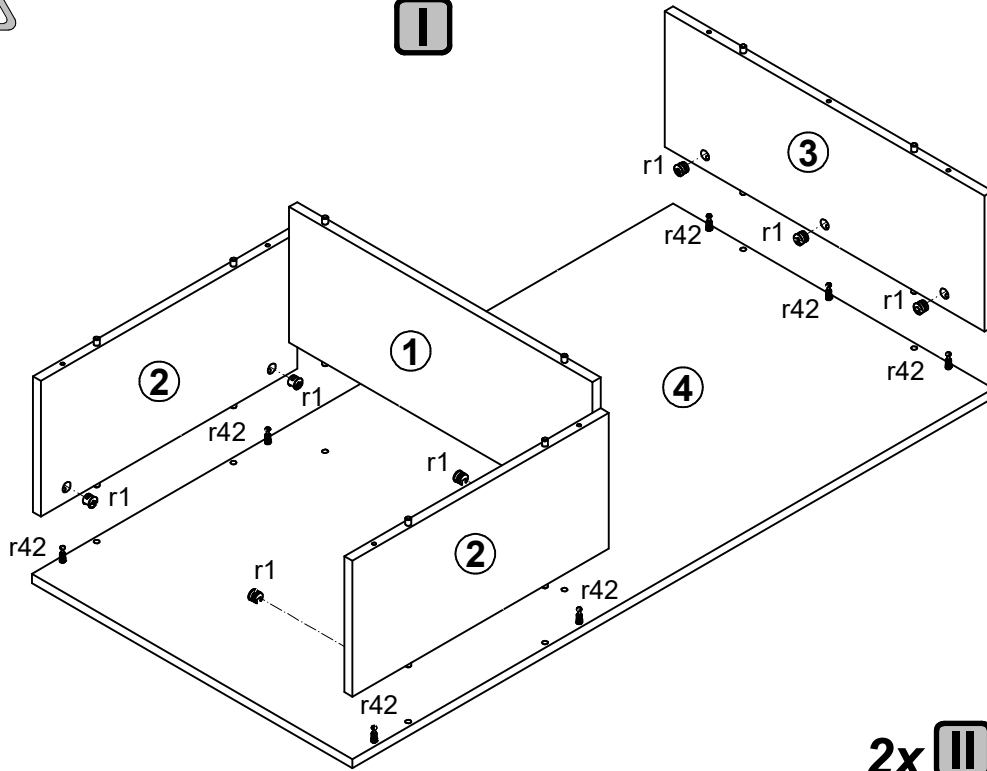

2x

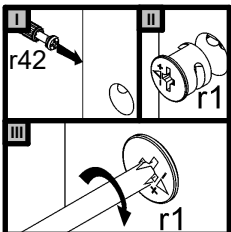
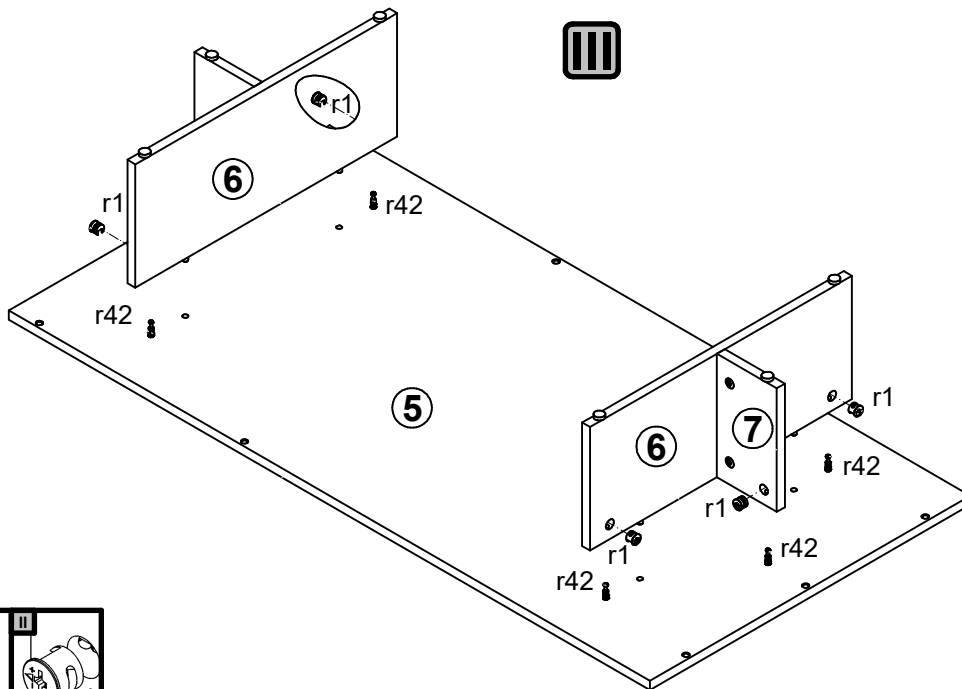
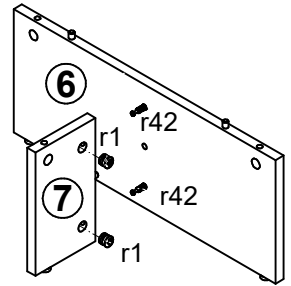

3

I

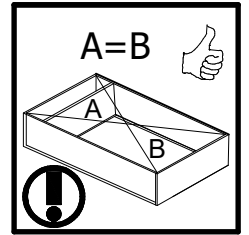
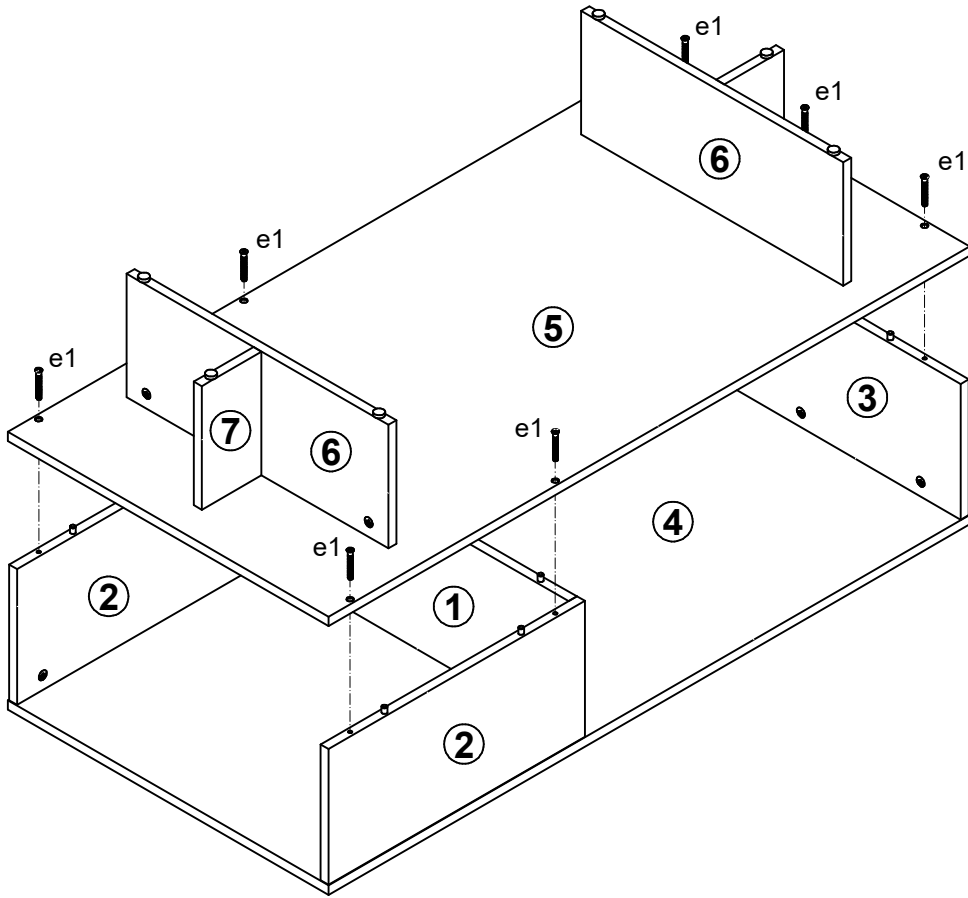

II

