

A	B	C	D	
1	S404-1008	1178	428	1/3
2	S404-1009	1178	428	1/3
3	S404-1010	388	402	1/3
4	S404-1011	388	402	1/3
5	S404-1012	693	408	1/3
6	S404-2003	1491	454	2/3
7	S404-3003	1459	428	2/3
8	S404-3004	945	407	1/3
9	S404-3005	496	407	1/3
10	S404-3006	1459	393	2/3
11	S404-4003	1459	160	2/3
12	S404-4004	1459	60	2/3
13	S404-5005	1350	70	2/3
14	S404-5006	1350	70	2/3
15	S404-5007	1178	70	1/3
16	S404-5008	1178	70	1/3
17	S404-5050	432	398	3/3
18	S404-5051	495	398	3/3
19	S404-5052	208	446	3/3
20	S404-9004	1106	509	1/3
21	S404-9303	1106	959	1/3
23	S407-0005	543	446	3/3
22	S407-0004	543	446	3/3
24	S407-0006	518	446	3/3
25	S407-0012	446	145	3/3
26	S407-0013	446	145	3/3
27	S407-0014	446	120	3/3
28	S407-0015	446	120	3/3
29	S407-0016	446	120	3/3

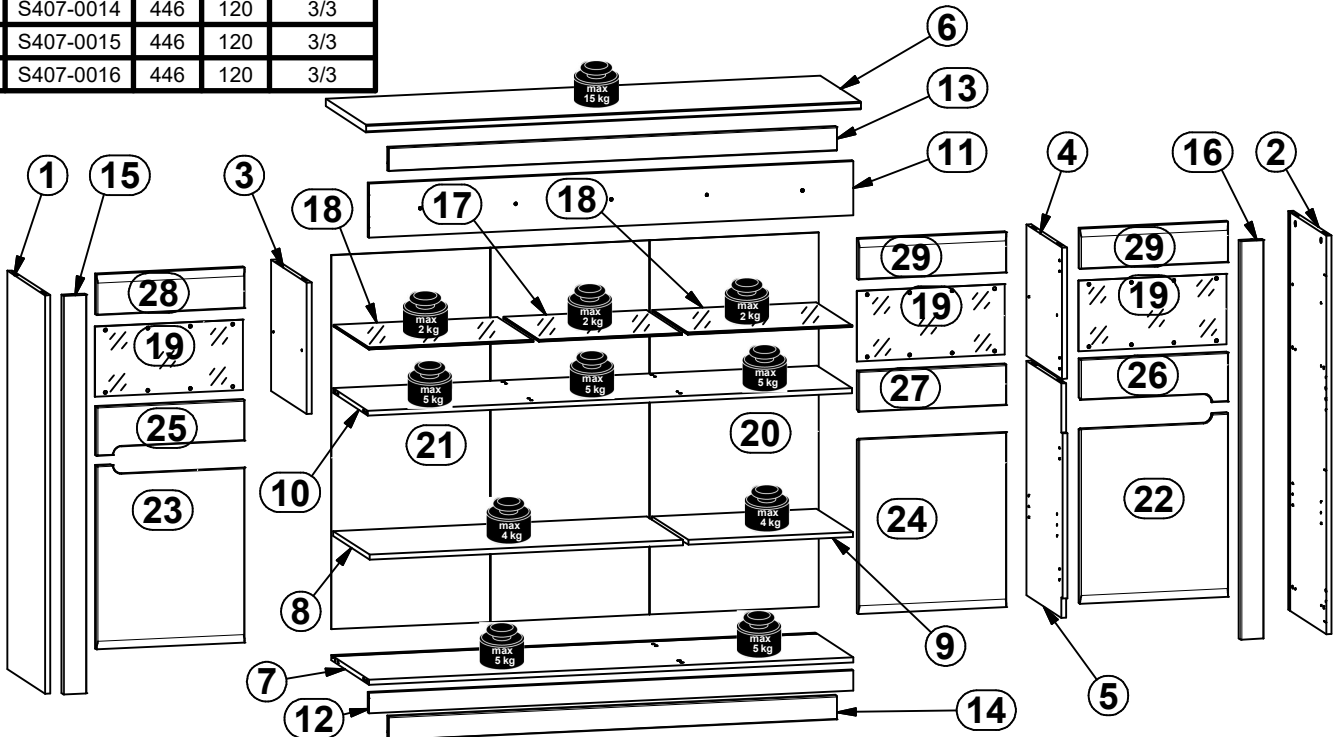

8x  a132	6x  a133	4x  a159	12x  b43	8x  d1	12x  d3	1x  d36	9x  d37	2x  e1
25x  e2	24x  e41	3x  e45	30x  f1	2x  f13	4x  k1	1x  k38l3	1x  k38l8	12x  l2
5x  n108	24x  o54	42x  p38	24x  p51	5x  p55	28x  r1	28x  r42	12x  s2	1x  z1
							1x  n26l1	1x  p38

1 §2

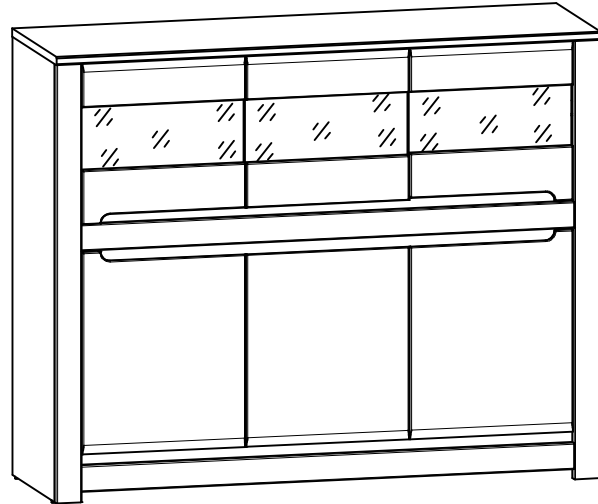
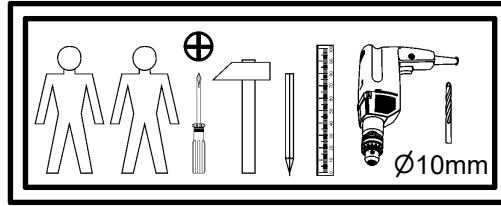
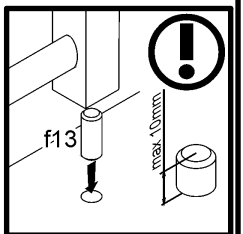
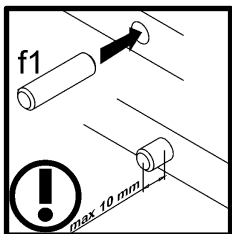
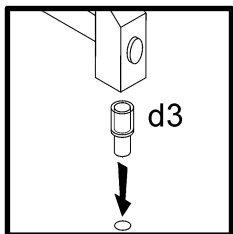
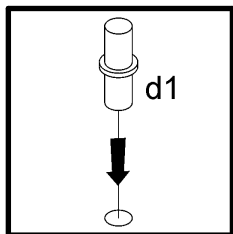
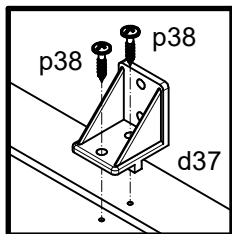
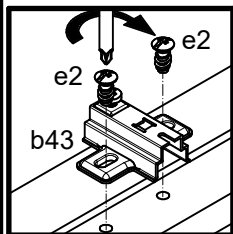
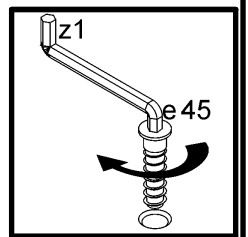
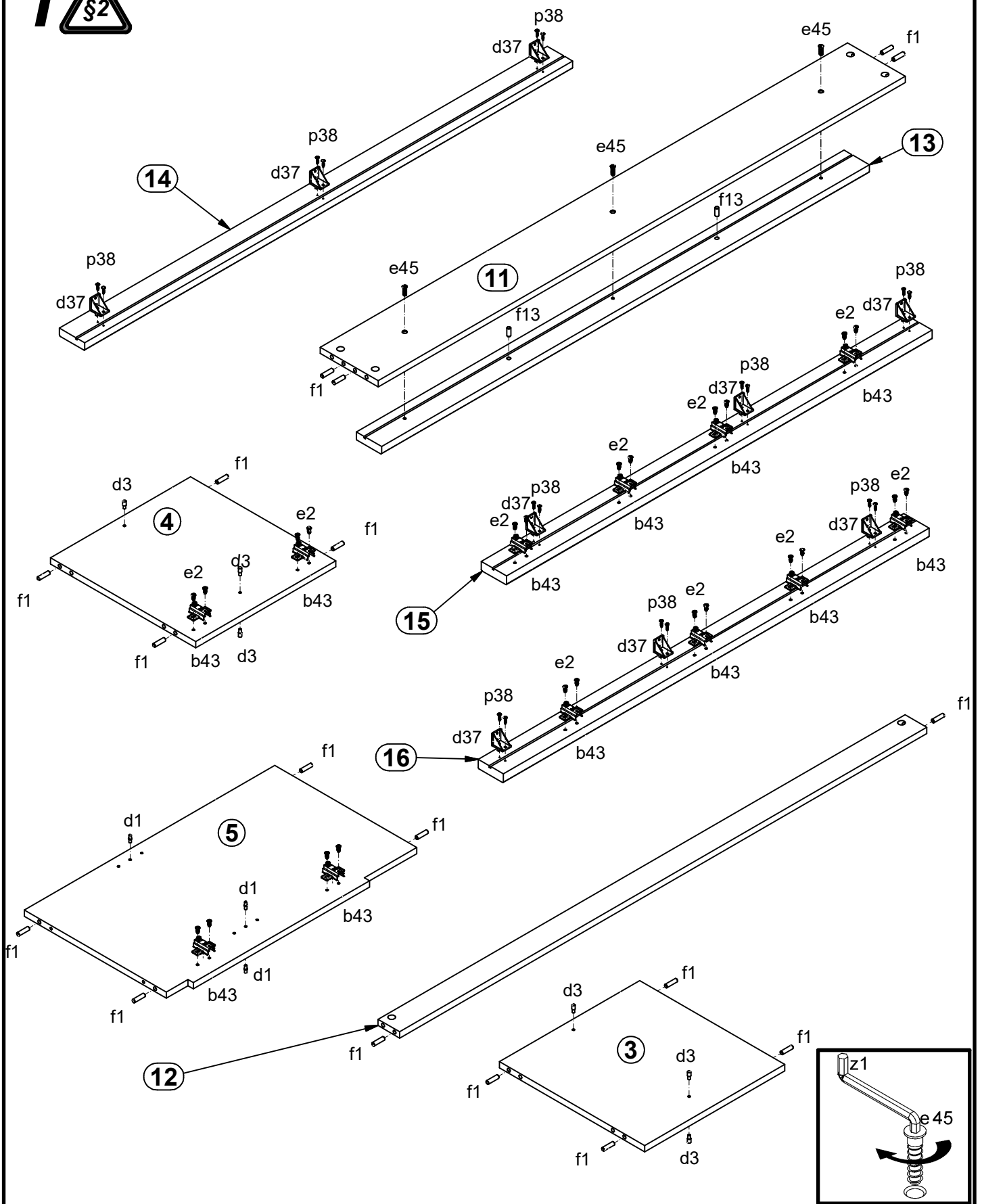

# 2

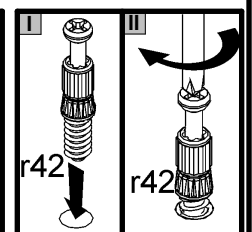
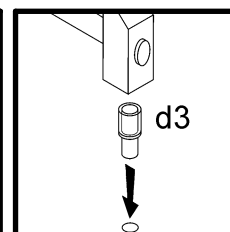
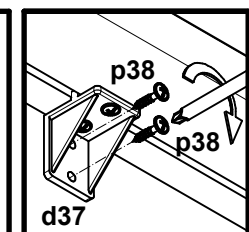
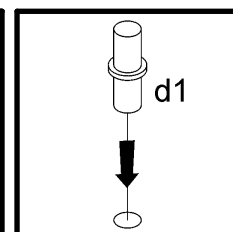
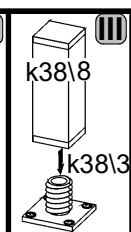
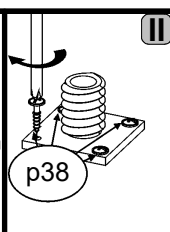
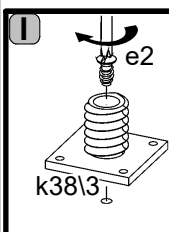
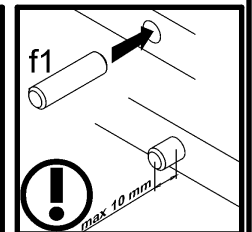
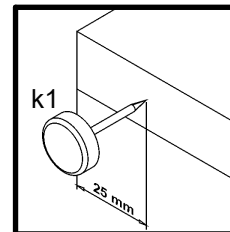
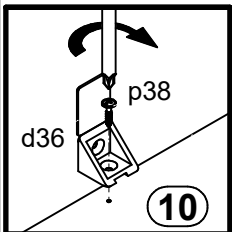
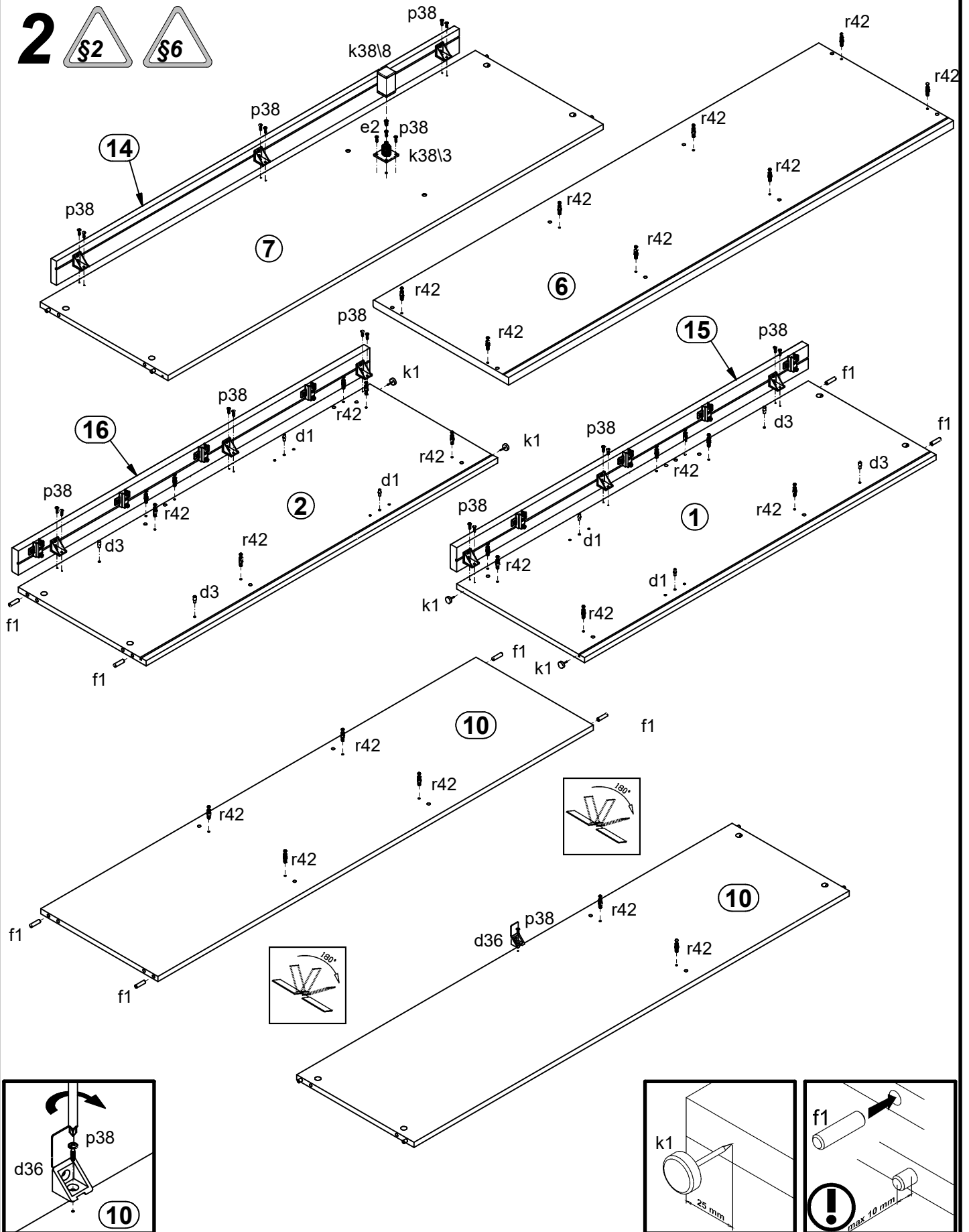

# 3

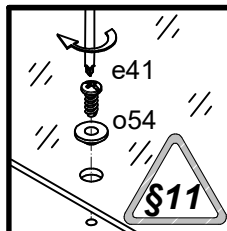
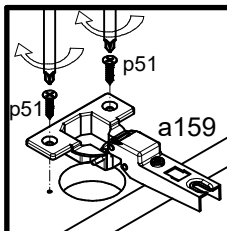
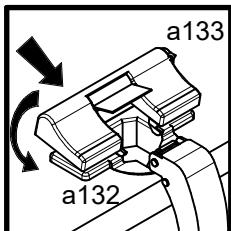
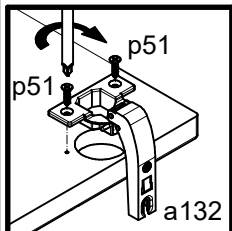
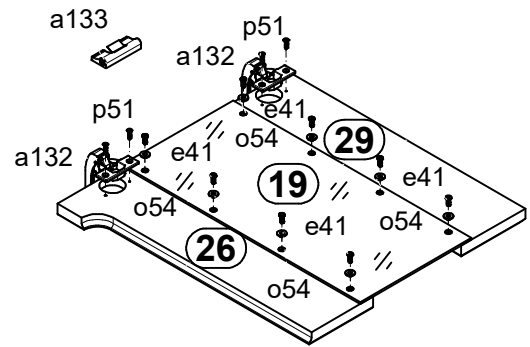
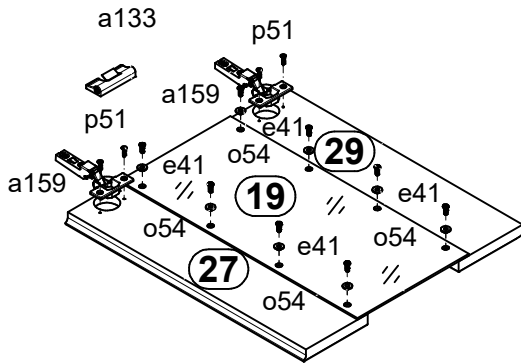
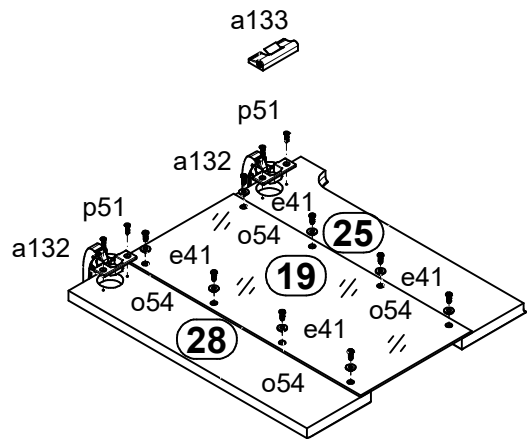
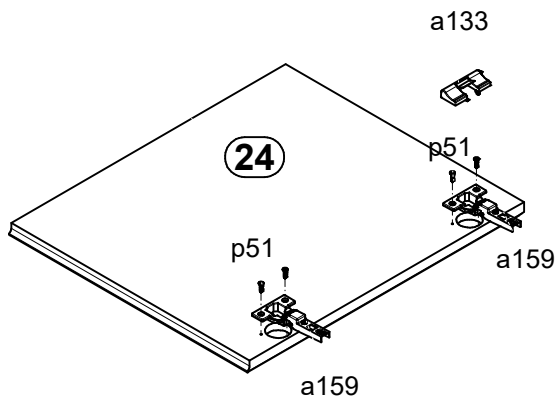
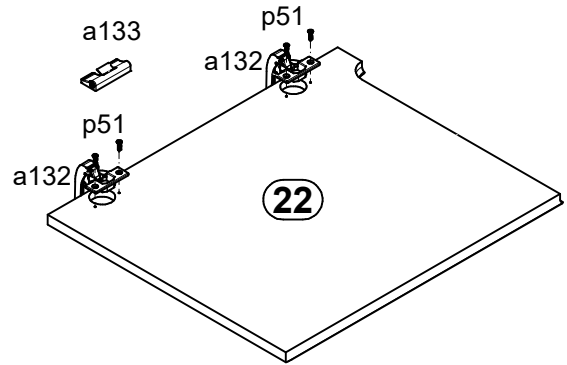
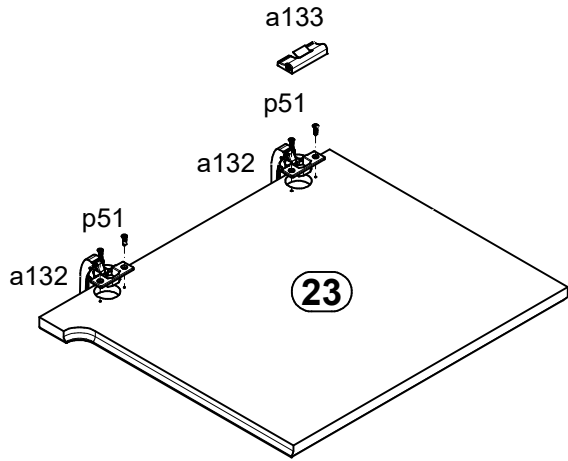

**4** §6

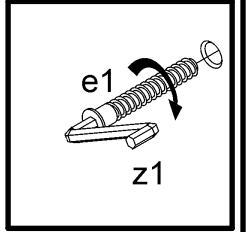
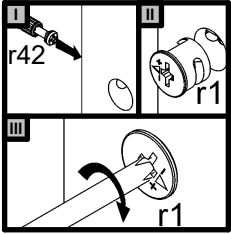
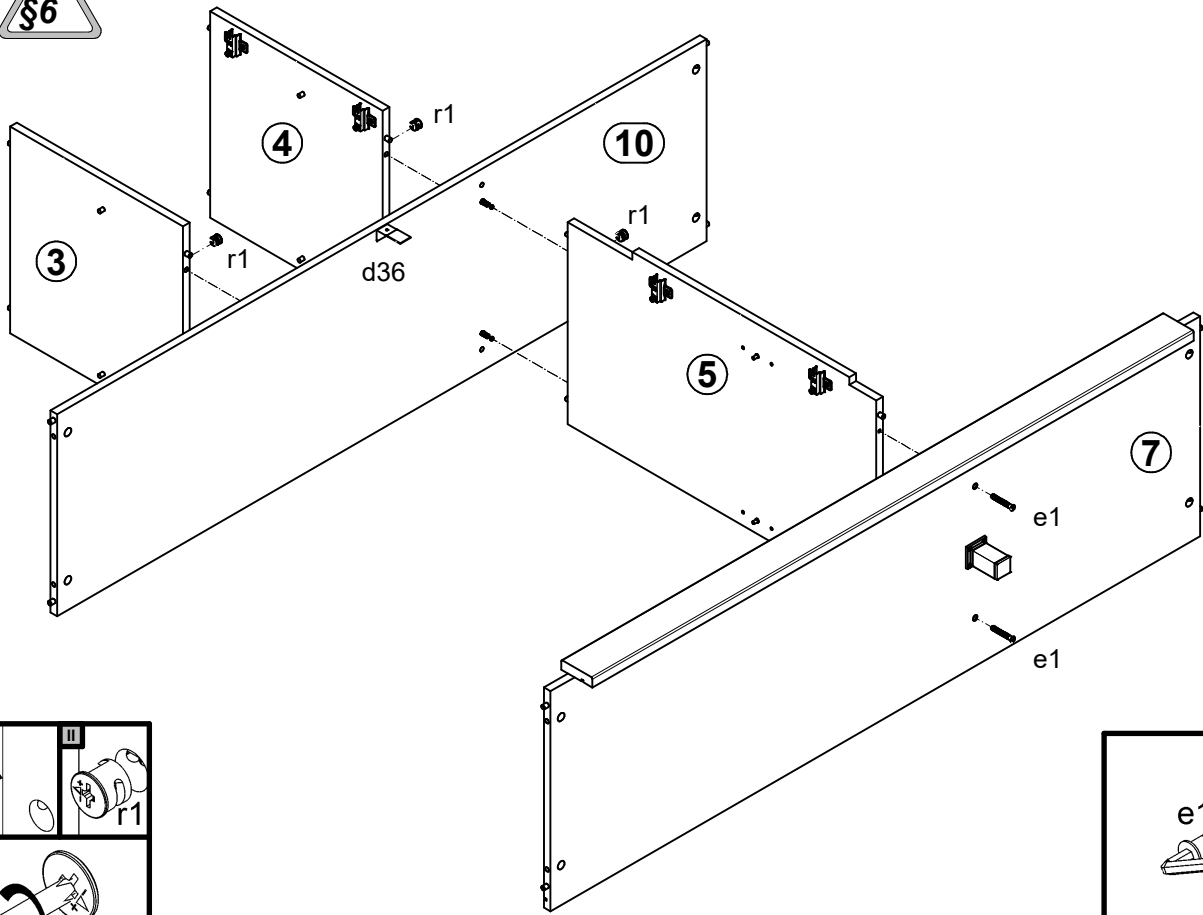

**5**

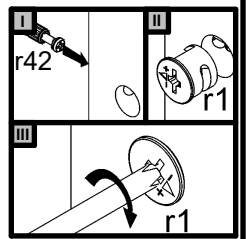
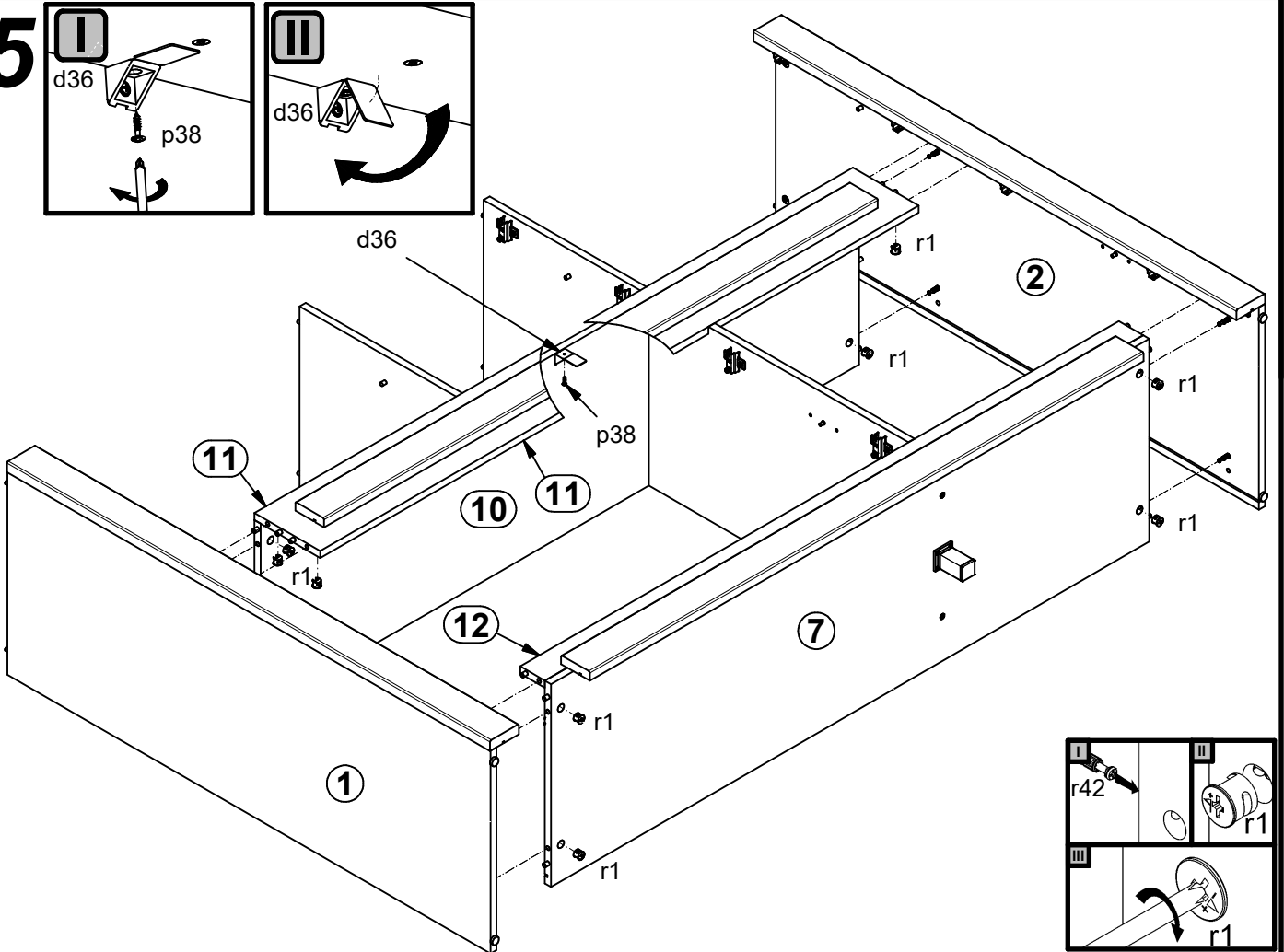
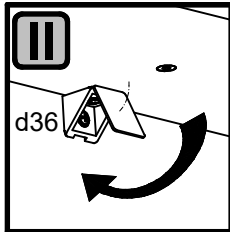
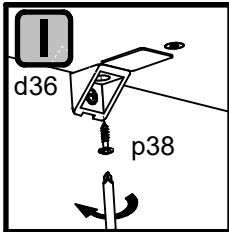

# 6

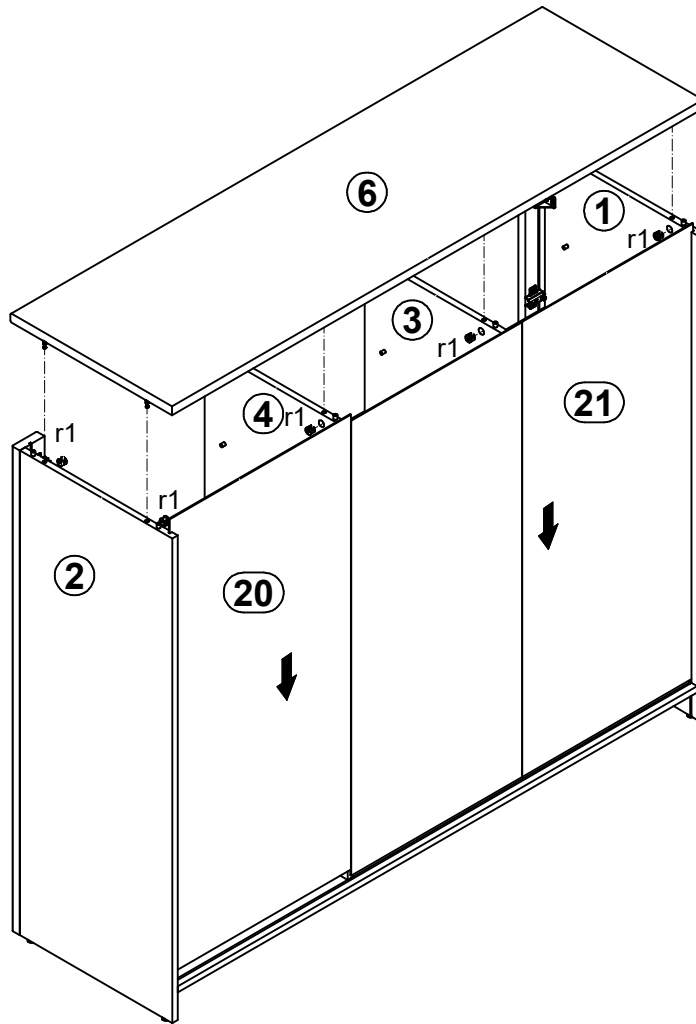

# 7

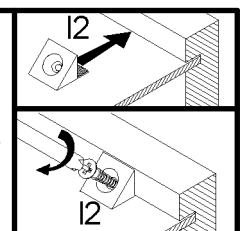
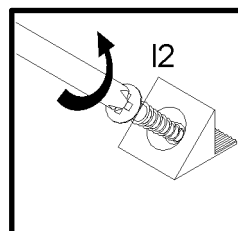
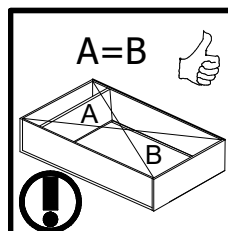
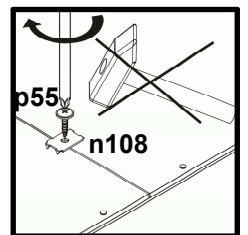
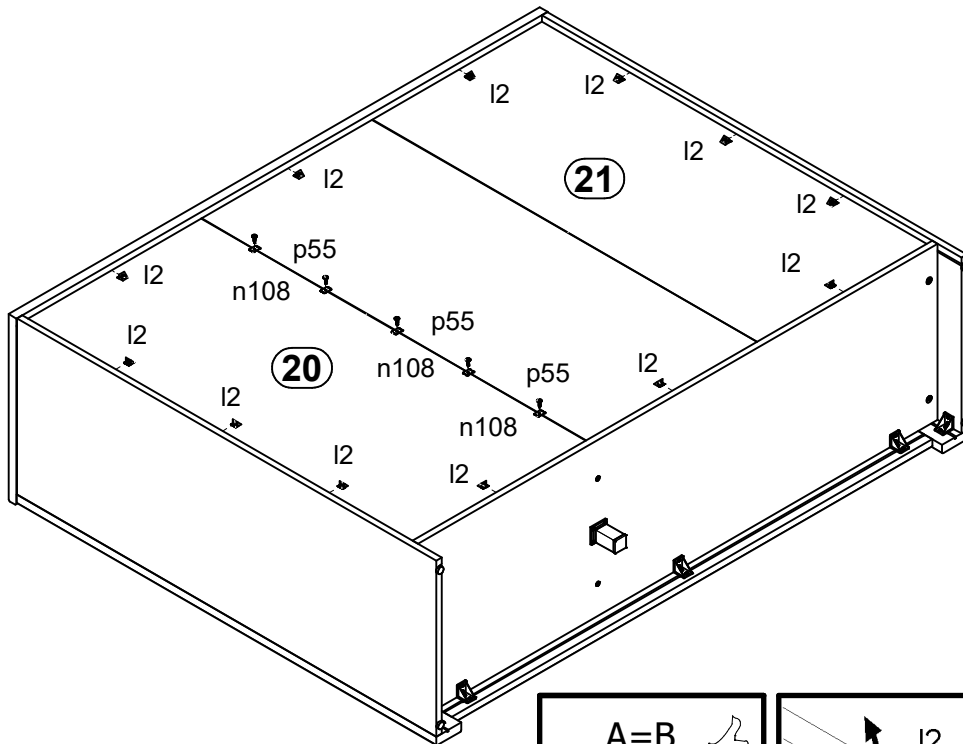

# 8

