

90 min

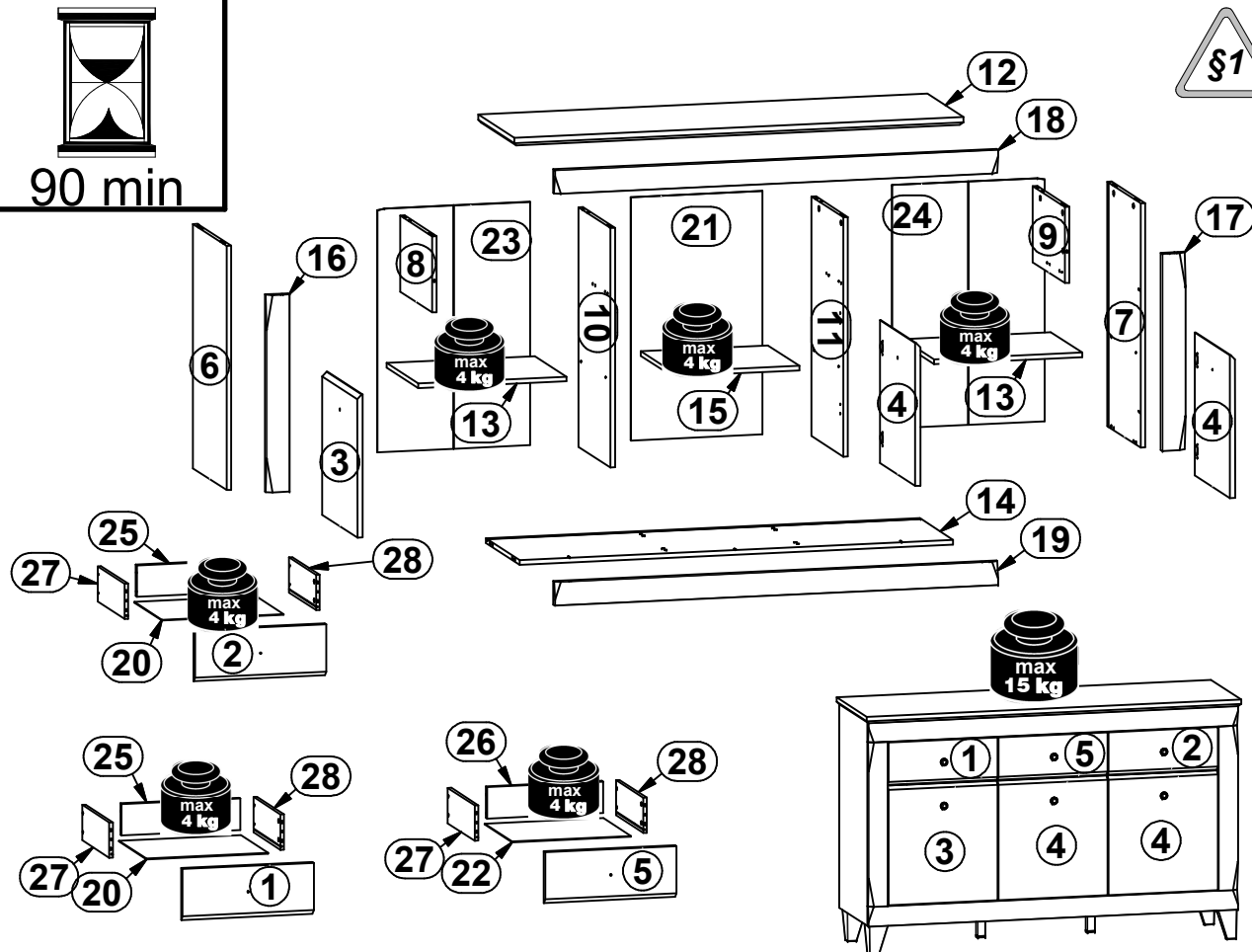

A	B	C (mm)			D
1	S359-0007	455	176	18	4/5
2	S359-0008	455	176	18	4/5
3	S359-0009	486	455	18	4/5
4	S359-0010	486	455	18	4/5
5	S359-0011	455	176	18	4/5
6	S359-1009	831	435	16	1/5
7	S359-1010	831	435	16	1/5
8	S359-1011	259	415	16	1/5
9	S359-1012	259	415	16	1/5
10	S359-1013	815	415	16	1/5
11	S359-1014	815	415	16	1/5
12	S359-2004	1558	468	28	2/5
13	S359-3006	514	409	16	2/5
14	S359-3007	1504	435	16	2/5
15	S359-3008	441	409	16	2/5
16	S359-5007	671	80	22	3/5
17	S359-5010	671	80	22	3/5
18	S359-5011	1537	80	22	3/5
19	S359-5012	1537	80	22	3/5
20	S359-9002	422	355	2,5	2/5
21	S359-9003	828	456	2,5	2/5
22	S359-9004	412	355	2,5	2/5
23	S359-9303	828	529	2,5	1/5
24	S359-9304	828	529	2,5	1/5
25	ZQ2-1513	412	107	16	1/5
26	ZQ2-1514	402	107	16	1/5
27	ZQ3-507	350	120	12	1/5
28	ZQ3-508	350	120	12	1/5

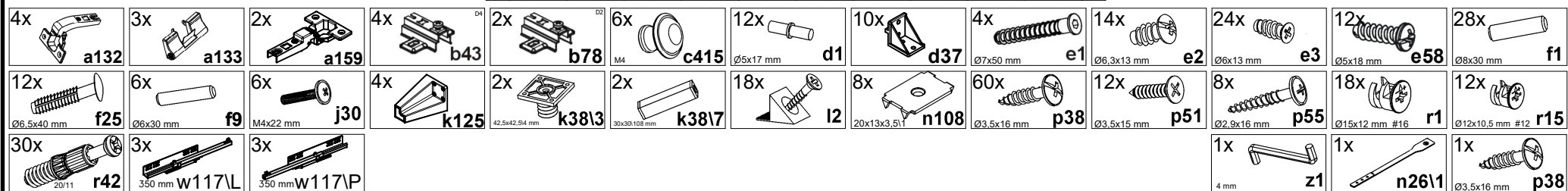

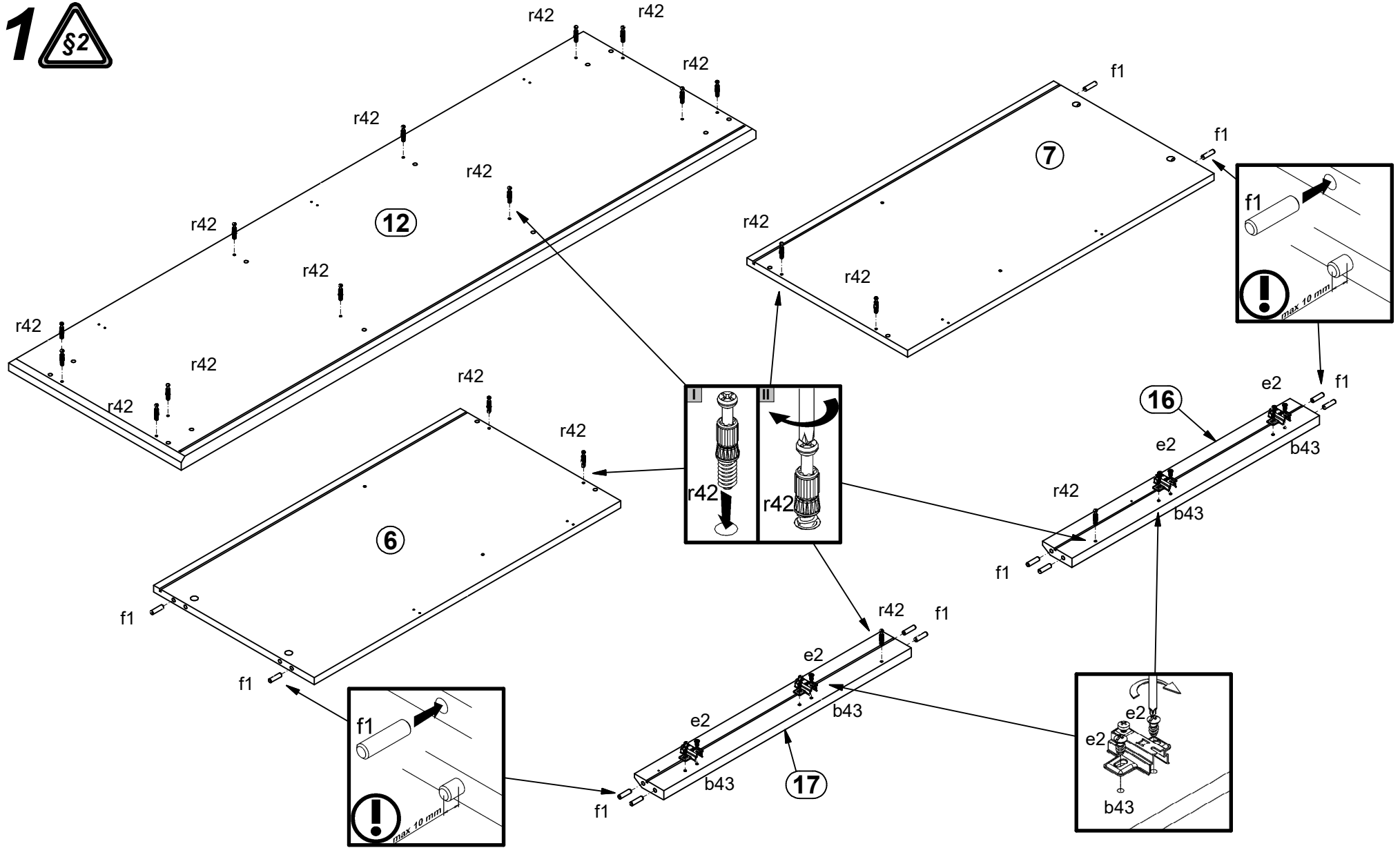

- 4x b43
- 8x e2  
Ø6,3x13 mm
- 12x f1  
Ø8x30 mm
- 18x r42  
20/11

2 

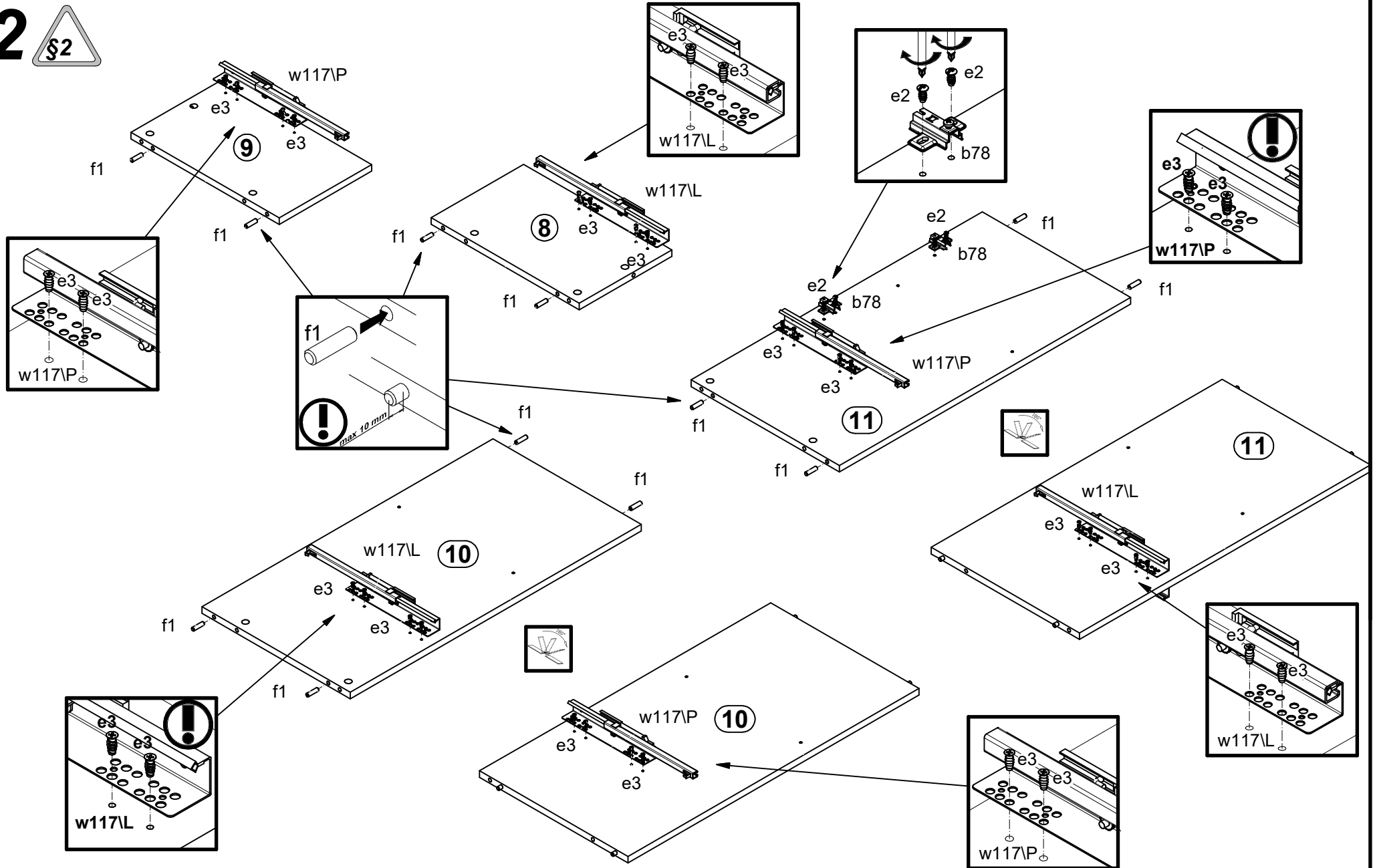

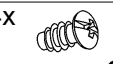
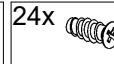
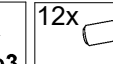
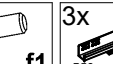
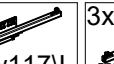

- |   |  |   |   |   |   |
|---|--|---|---|---|---|
|  2x <b>b78</b> |  4x <b>e2</b><br>Ø6x13 mm |  24x <b>e3</b><br>Ø6x13 mm |  12x <b>f1</b><br>Ø8x30 mm |  3x <b>350 mm W117/L</b> |  3x <b>350 mm W117/P</b> |
|---|--|---|---|---|---|

3 

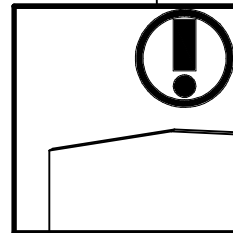
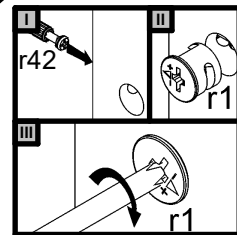
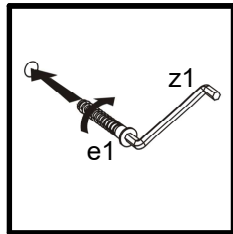
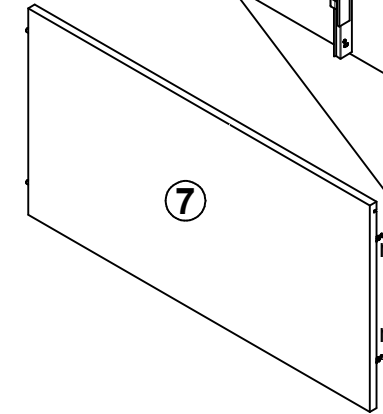
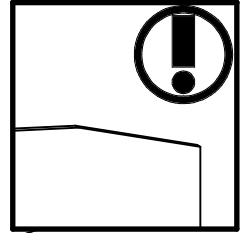
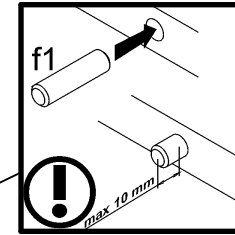
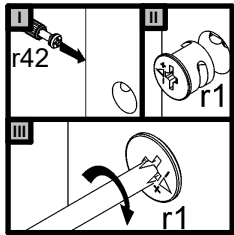
4 



4x  e1  
Ø7x50 mm

4x  f1  
Ø8x30 mm

4x  r1  
Ø15x12 mm #16

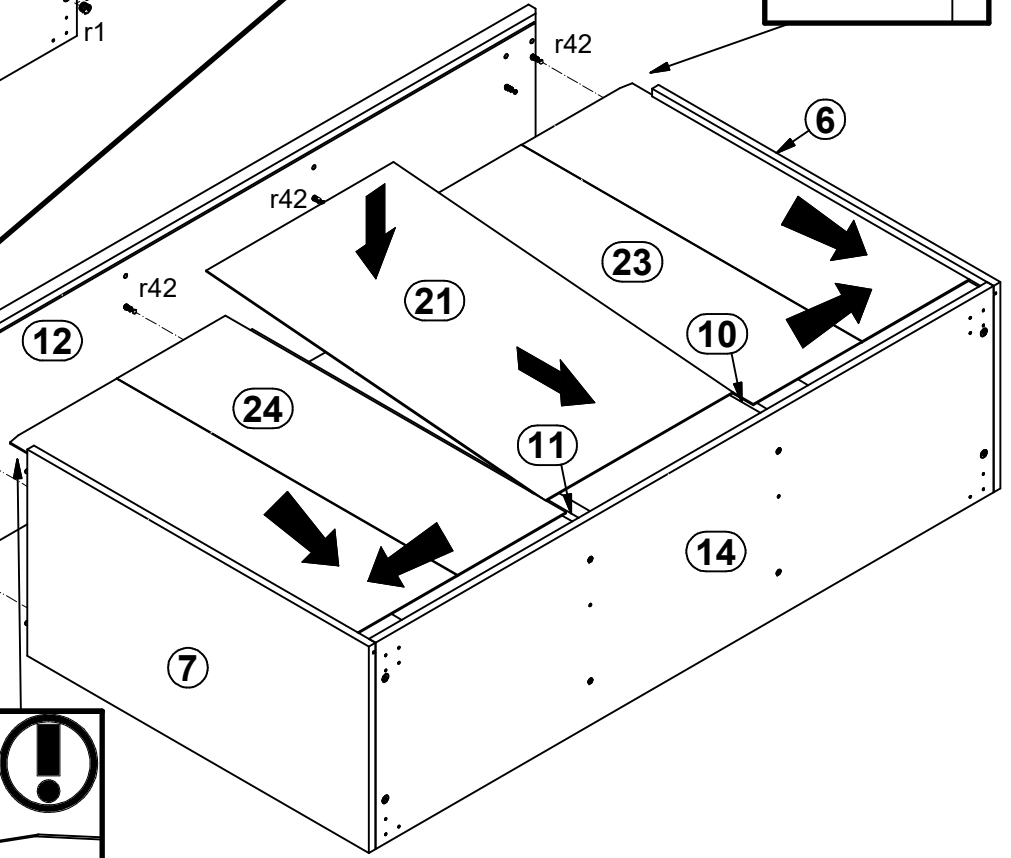
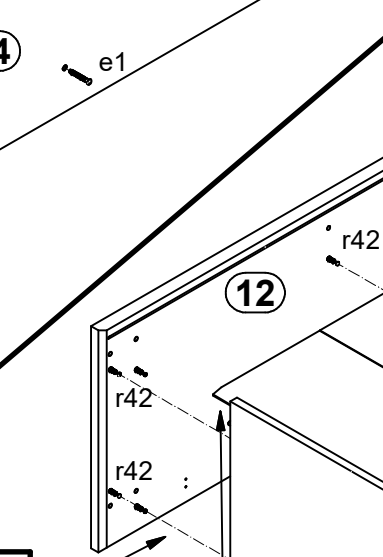
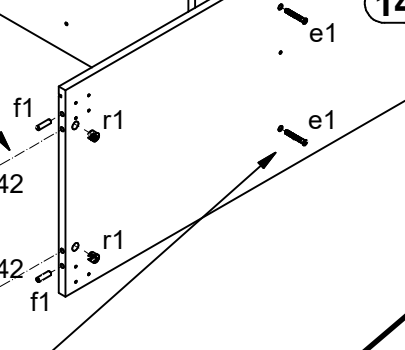
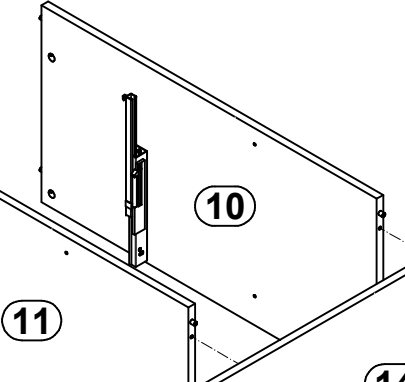
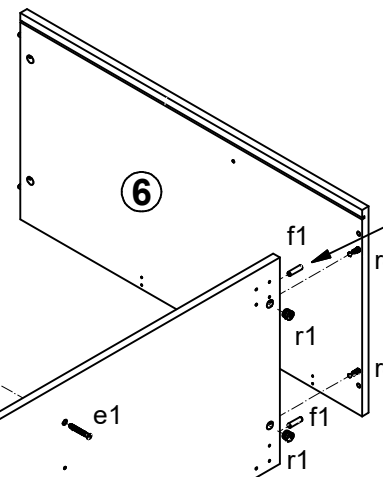

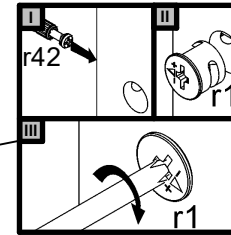
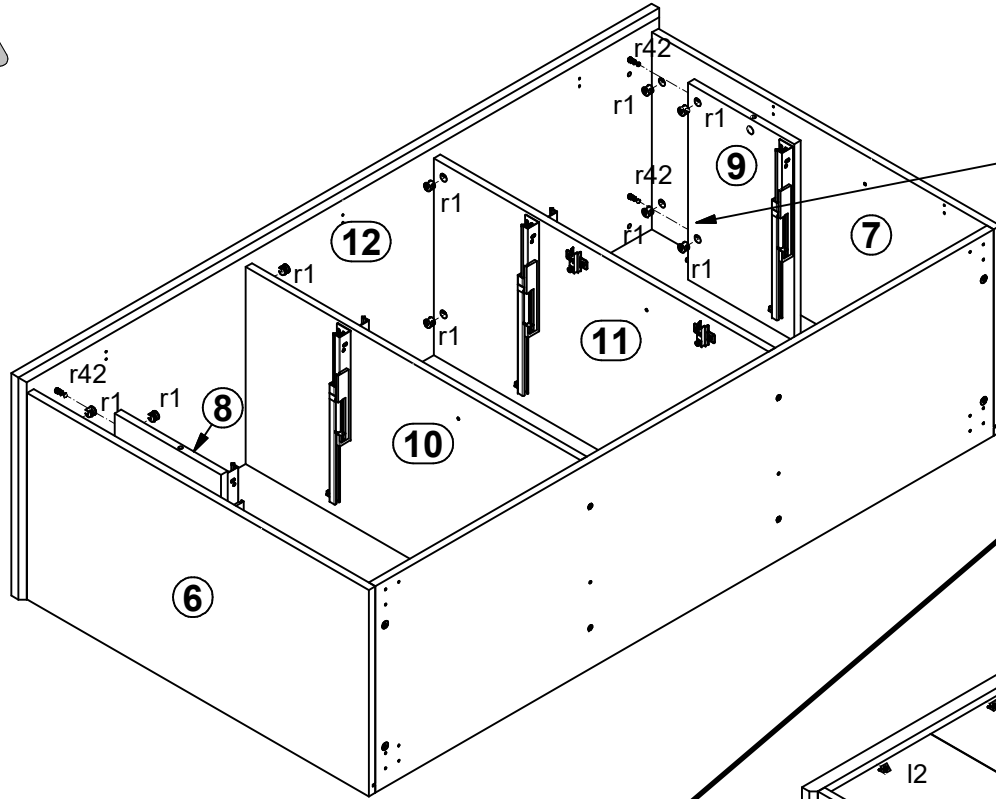

5 

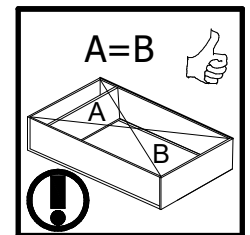
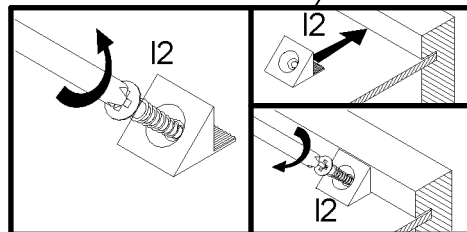
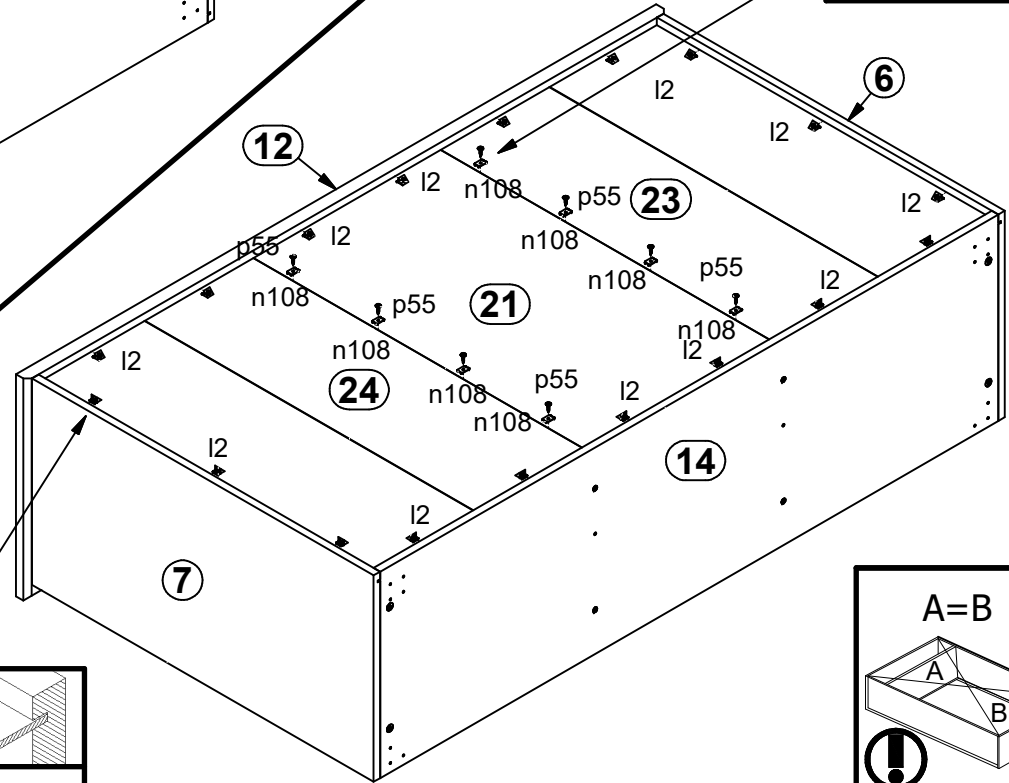
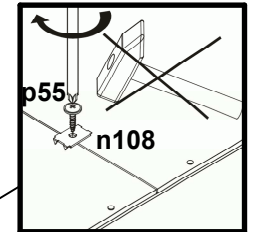

6 



12x  r1  
Ø15x12 mm #16

18x  l2

8x  n108  
20x13x3.5 l

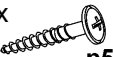
8x  p55  
Ø2.9x16 mm





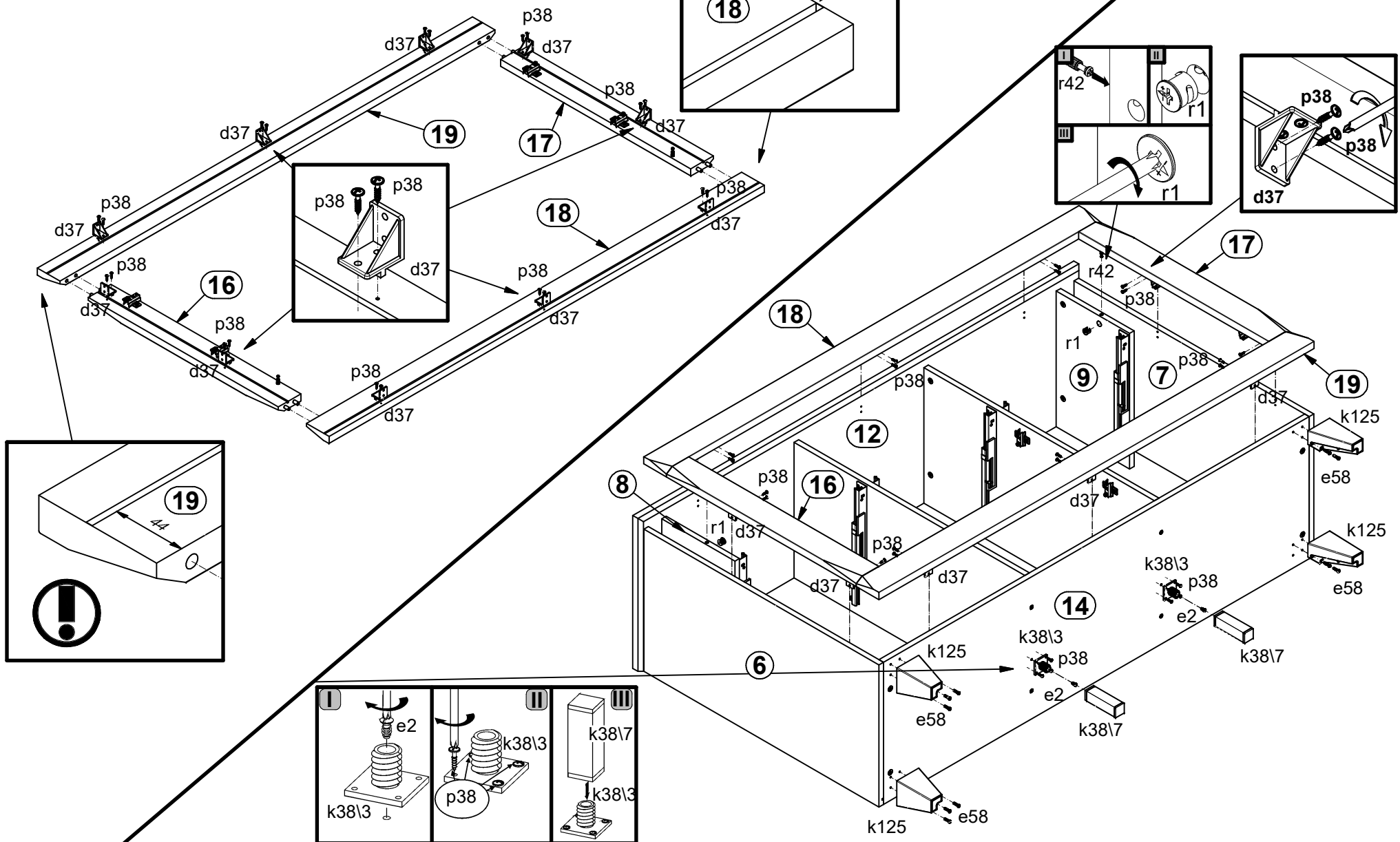

7 

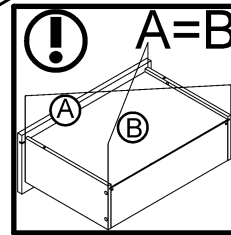
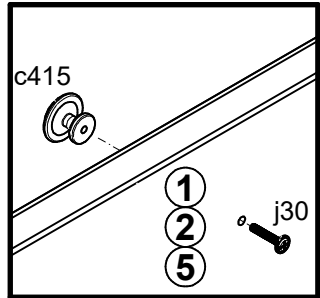
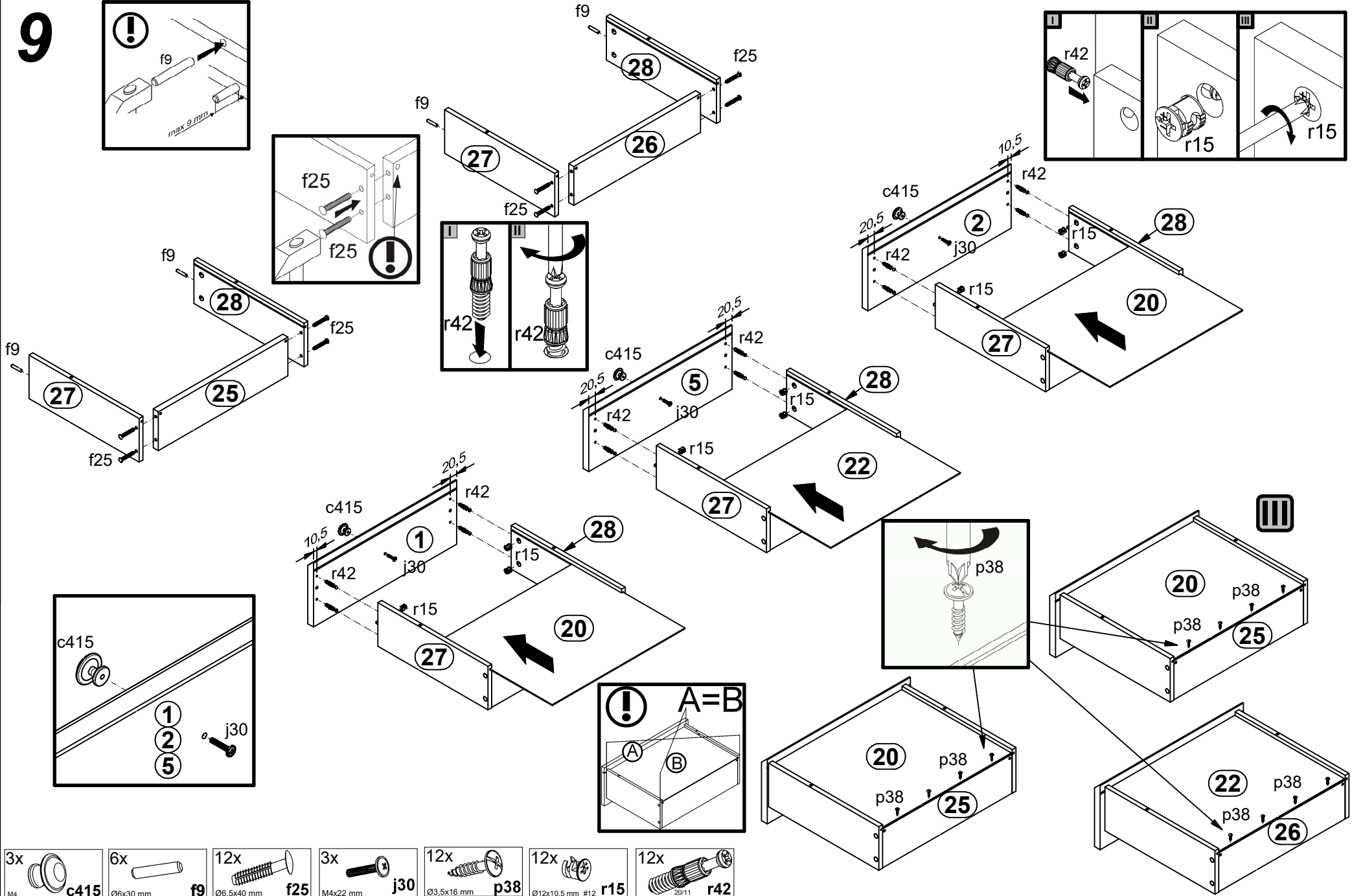
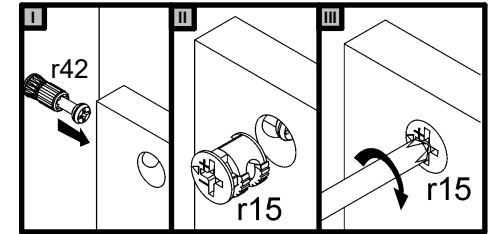
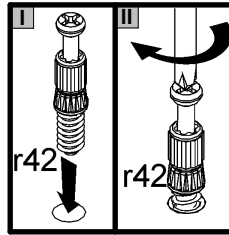
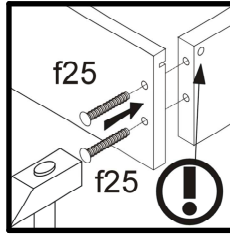
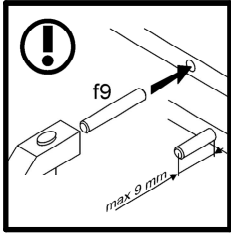
8 



9



- 3x  
M4  
 c415
- 6x  
 f9  
Ø6x30 mm
- 12x  
 f25  
Ø6,5x40 mm
- 3x  
 j30  
M4x22 mm
- 12x  
 p38  
Ø3,5x16 mm
- 12x  
 r15  
Ø12x10,5 mm #12
- 12x  
 r42  
20/11



# 10

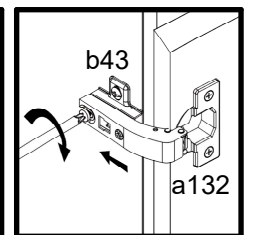
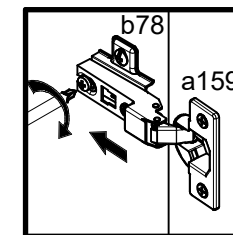
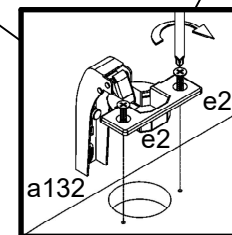
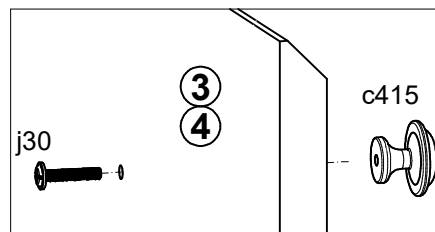
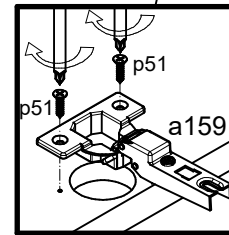
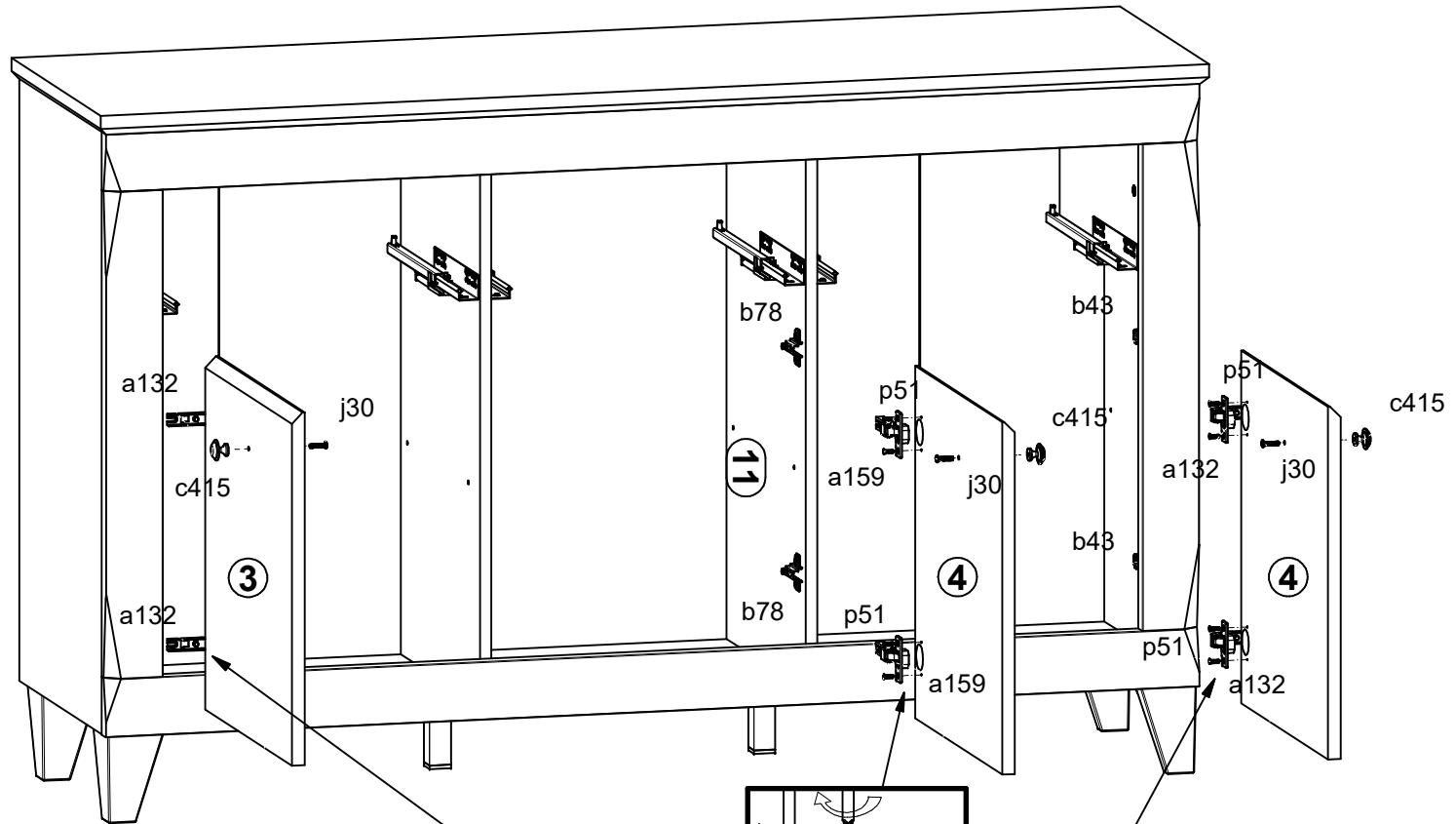

- 4x  **a132**
- 2x  **a159**
- 3x  **c415**
- 3x  **j30**
- 12x  **p51**

# 11

