

A	B	C (mm)	D
1	S220-0001	2100	526
2	S220-1001	2048	540
3	S220-1002	2048	540
4	S220-1006	1729	510
5	S220-1007	2048	520
6	S220-2005	2225	540
7	S220-2006	2225	540
8	S220-3002	1088	520
9	S220-3003	558	505
10	S220-3004	1088	520
11	S220-5502	400	179
12	S220-7001	2100	596
13	S220-7004	100	336
14	S220-9303	2058	1101
15	dr-1085	1085	30
16	dr-506	506	22

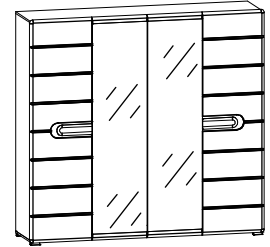

8x a108	8x a109	16x b51	12x d1 Ø5x17 mm	12x e1 Ø7x50 mm	20x f1 Ø8x30 mm	2x f6 Ø8x50 mm	3x k53	4x k77 84x40/25 mm	37x l1	32x l2	4x n1 h=22mm	14x n108 20x13x3.5/1
16x o54 Ø5.3/Ø8.3x4.8 mm	4x p1 Ø3.5x13 mm	11x p36 Ø4x25 mm	16x p38 Ø3.5x16 mm	32x p51 Ø3.5x15 mm	14x p55 Ø2.9x16 mm	12x r1 Ø15x12 mm #16	12x r3 Ø15x15 mm #22	3x r28 36/20 mm	18x r42	24x s2 Ø16	1x z1	
											2x n26/1	2x p38 Ø3.5x16 mm

1 

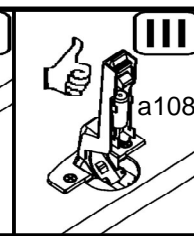
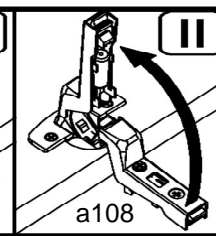
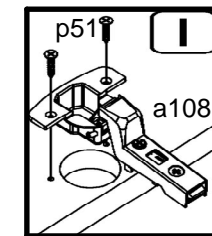
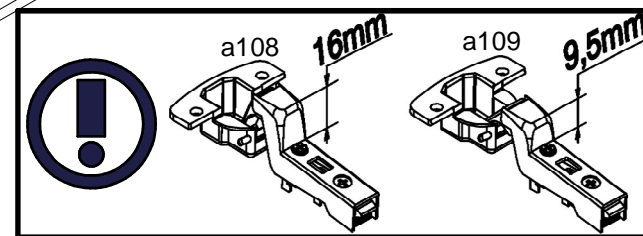
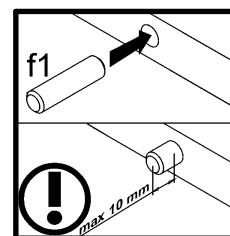
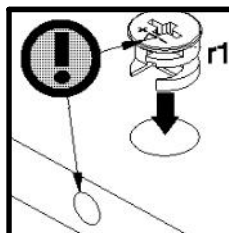
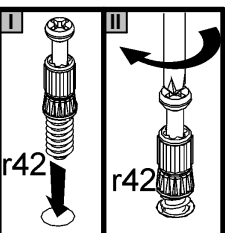
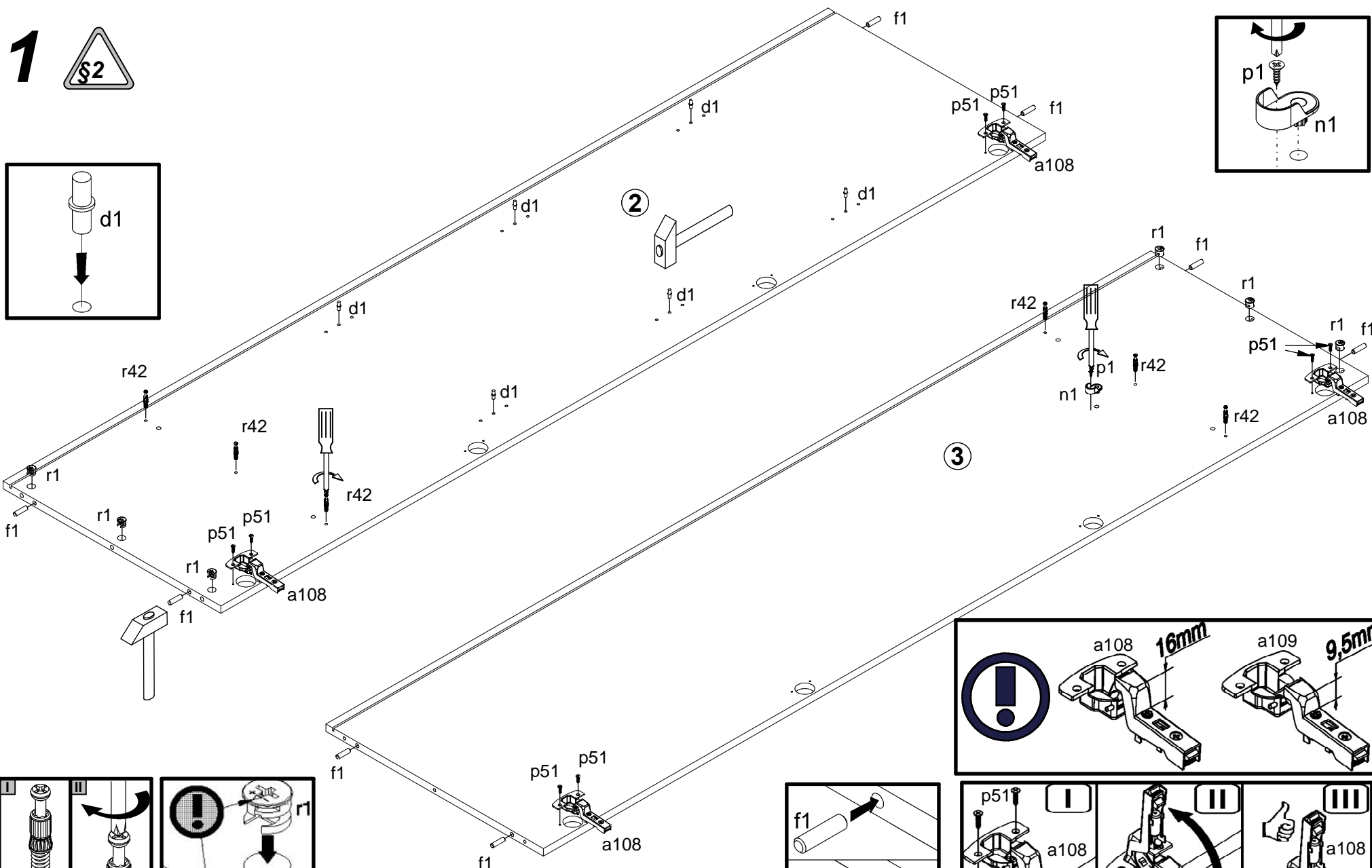
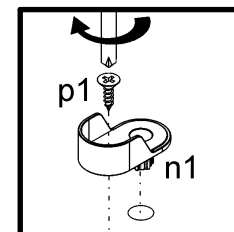
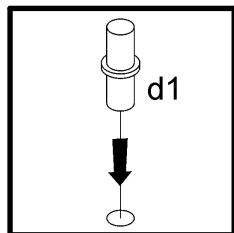

1

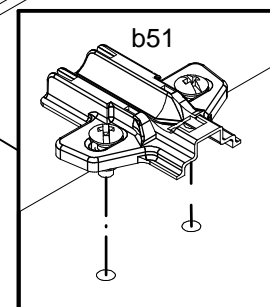
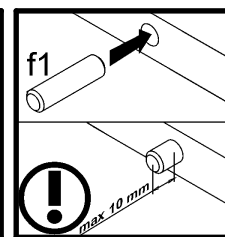
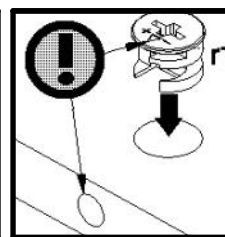
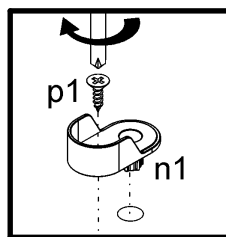
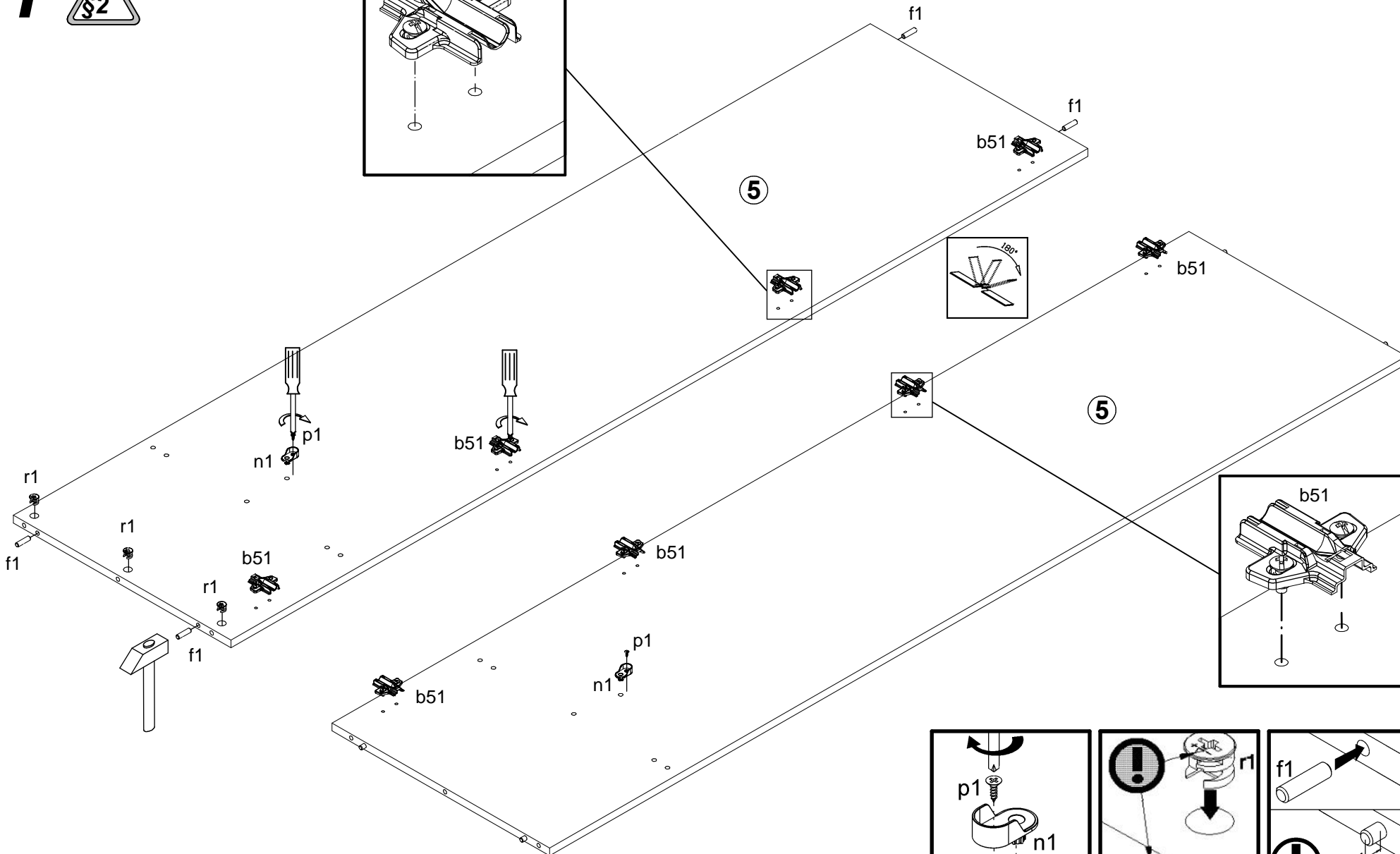
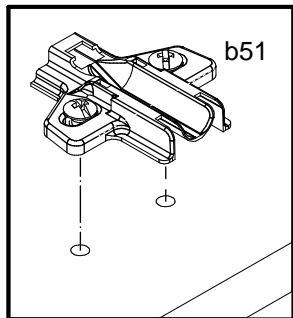

1

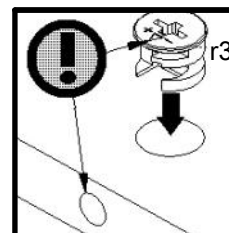
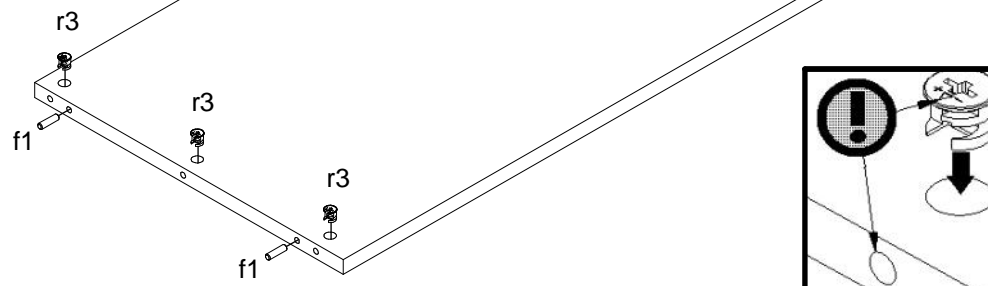
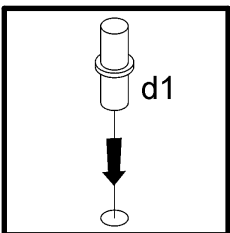
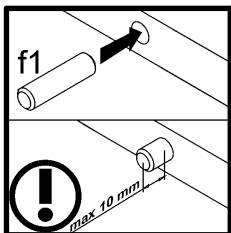
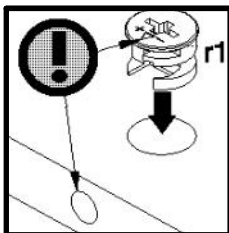
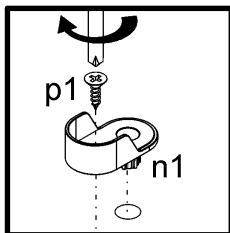
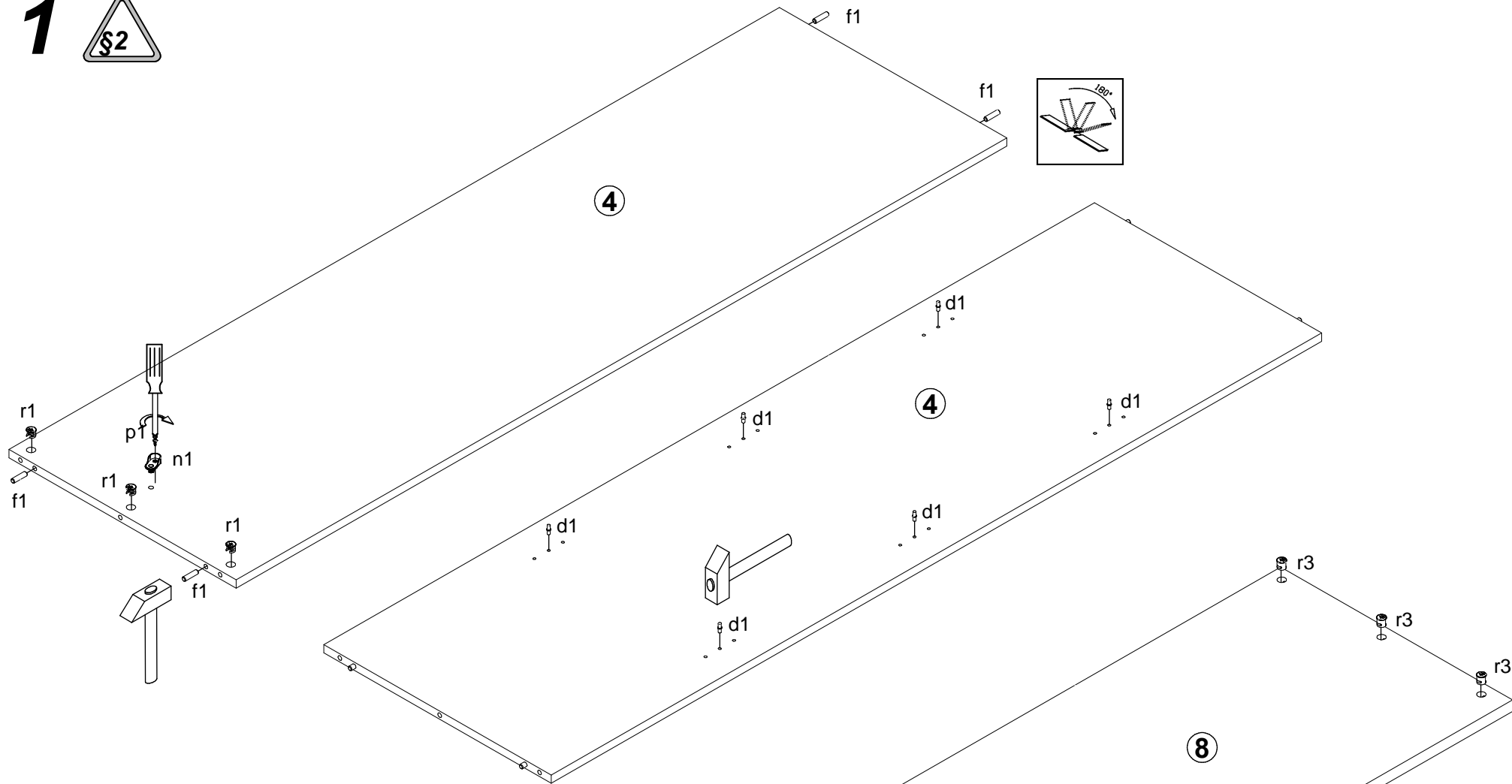

1

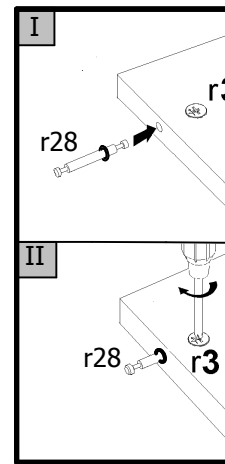
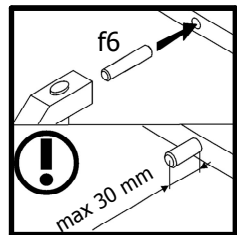
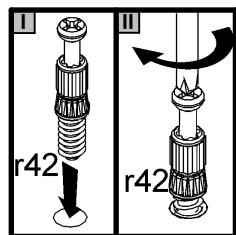
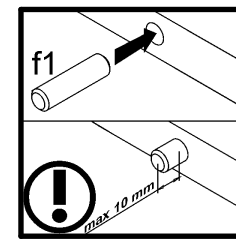
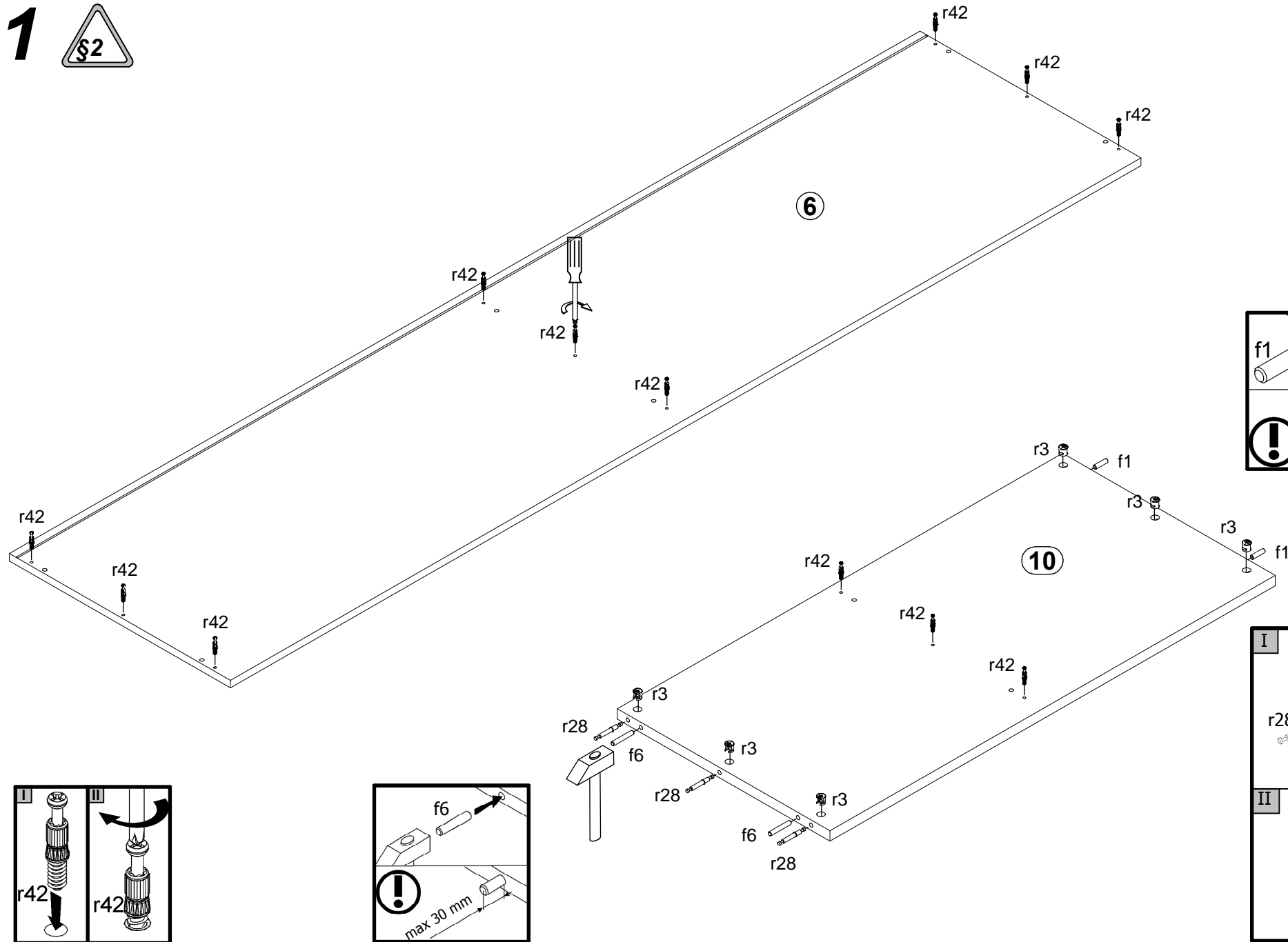

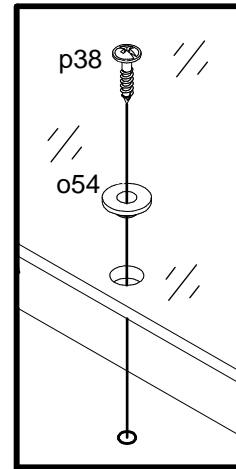
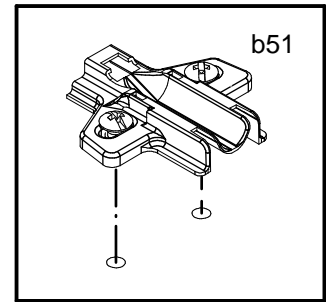
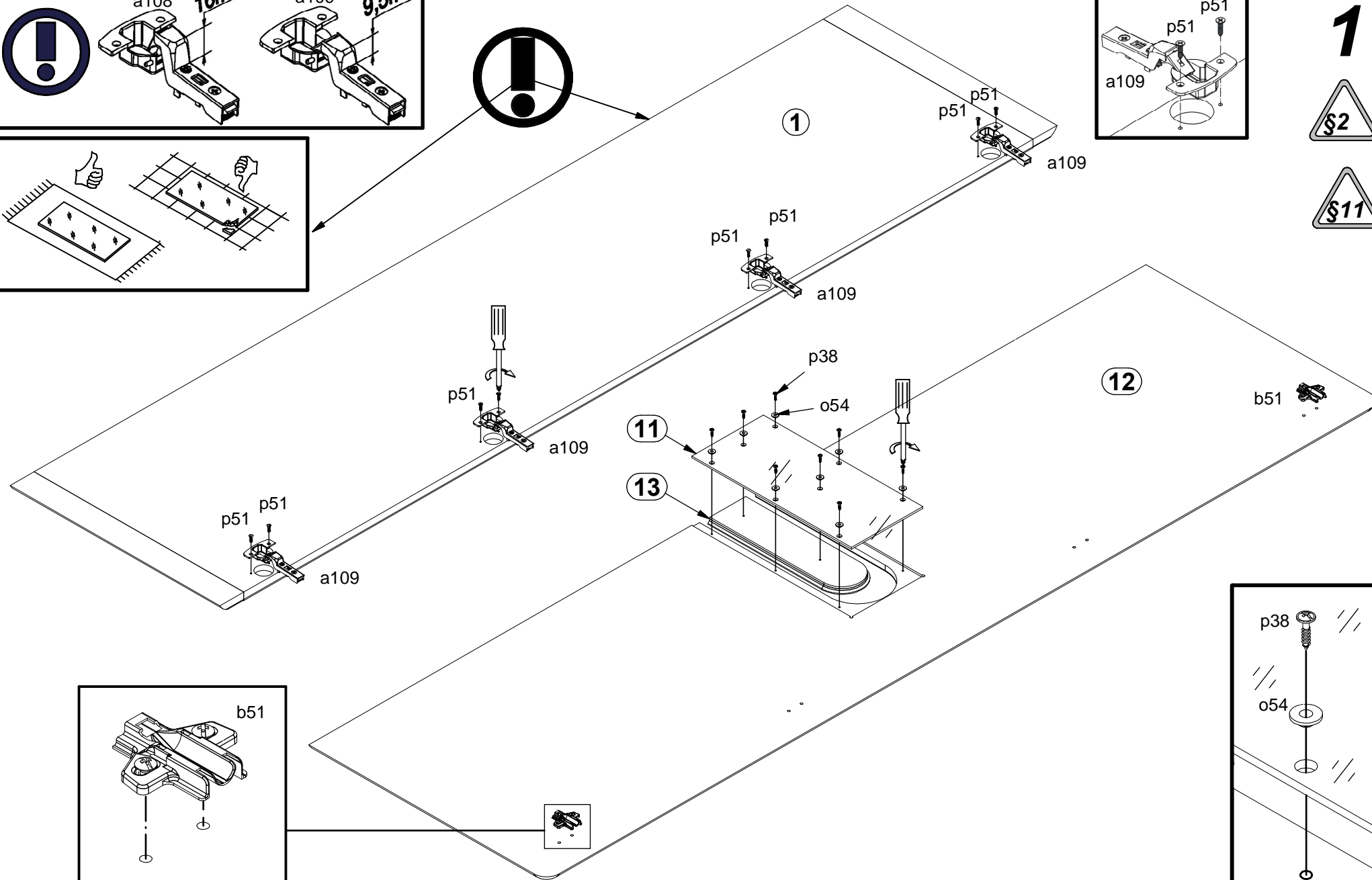
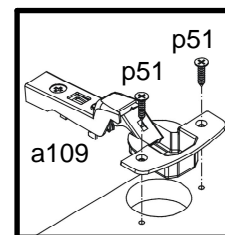
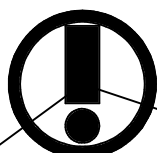
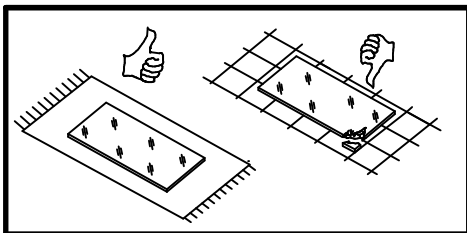
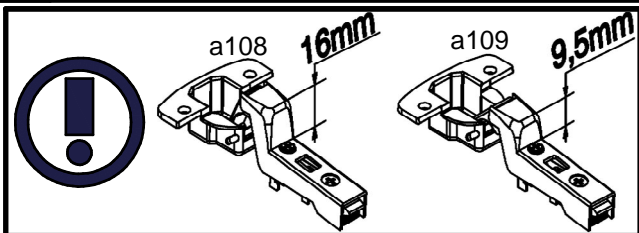

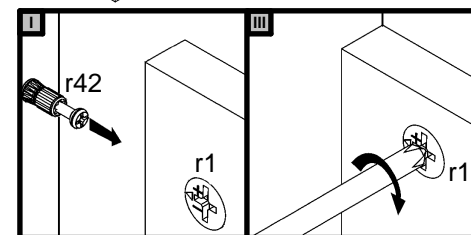
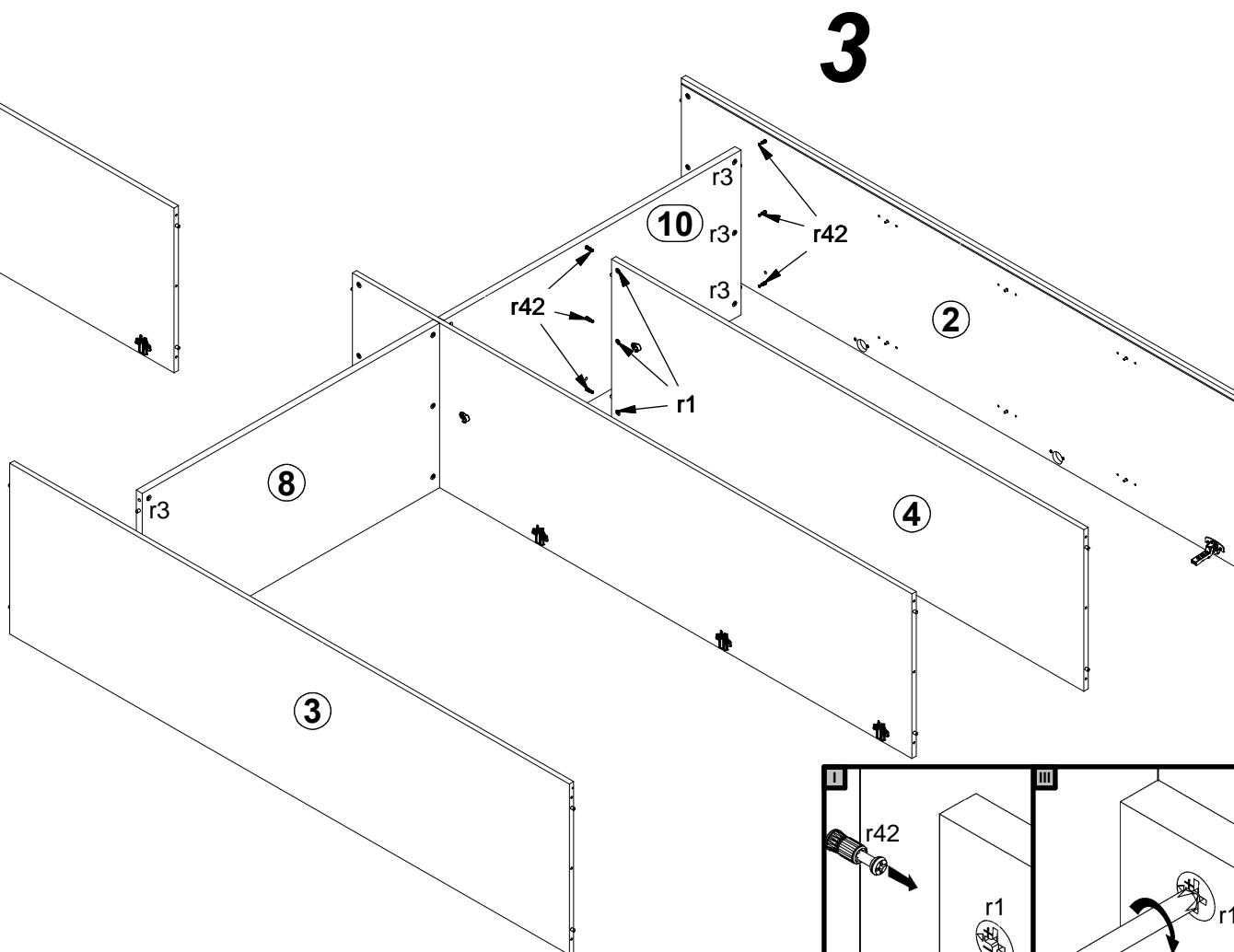
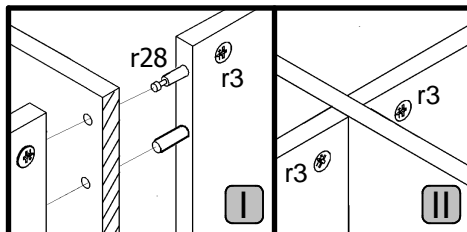
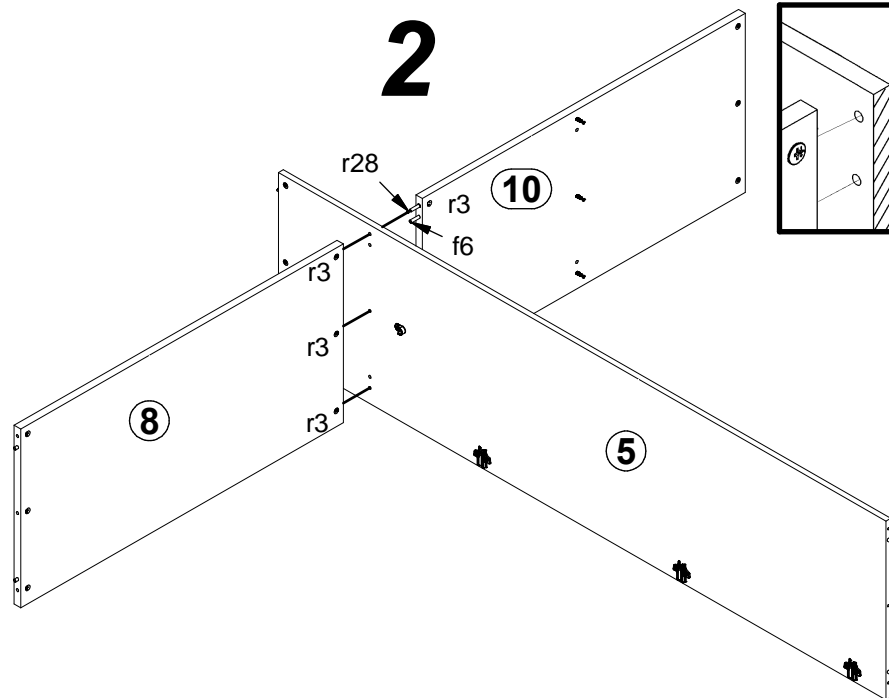





4

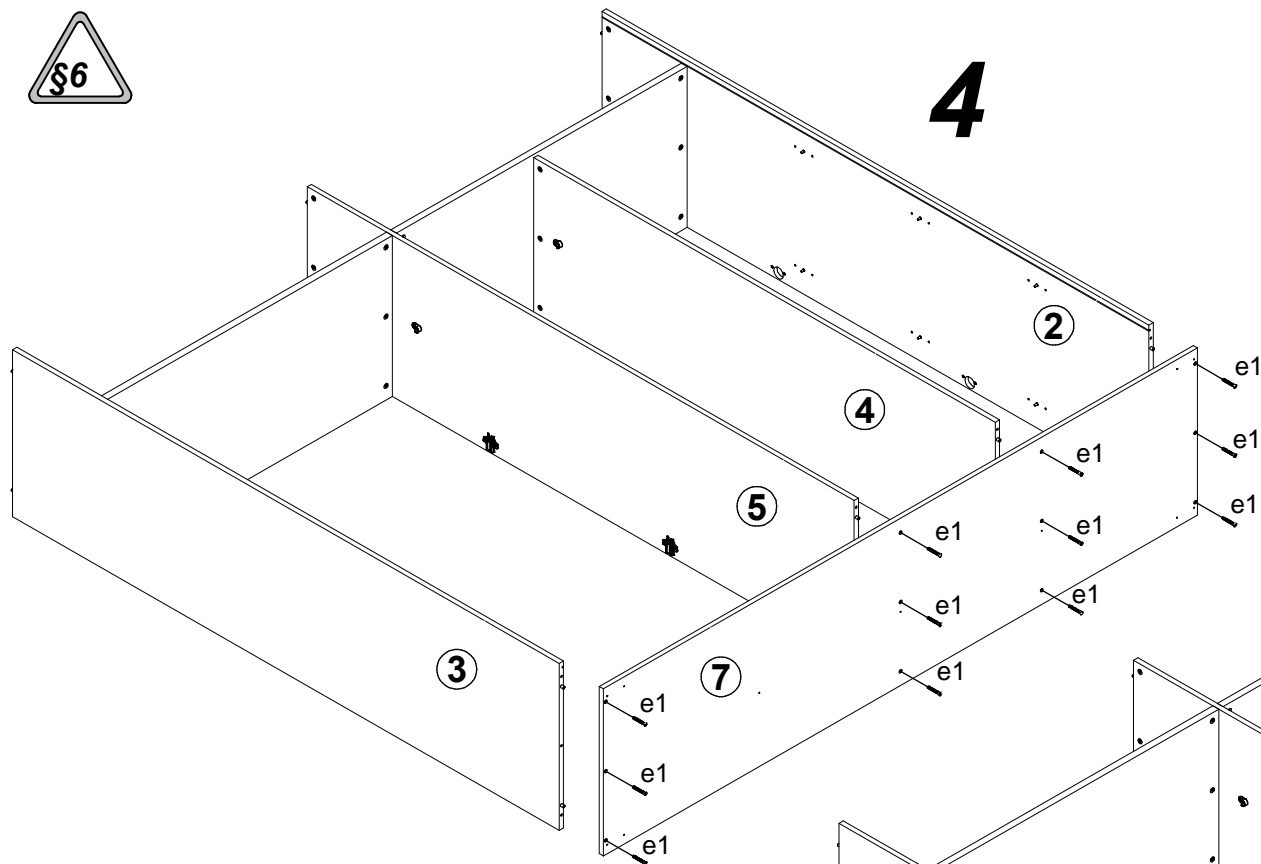
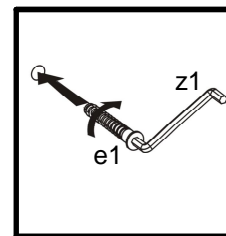

5

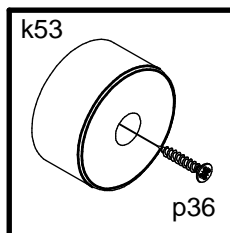
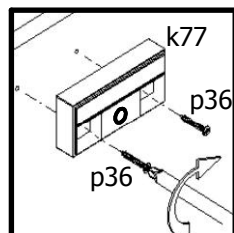
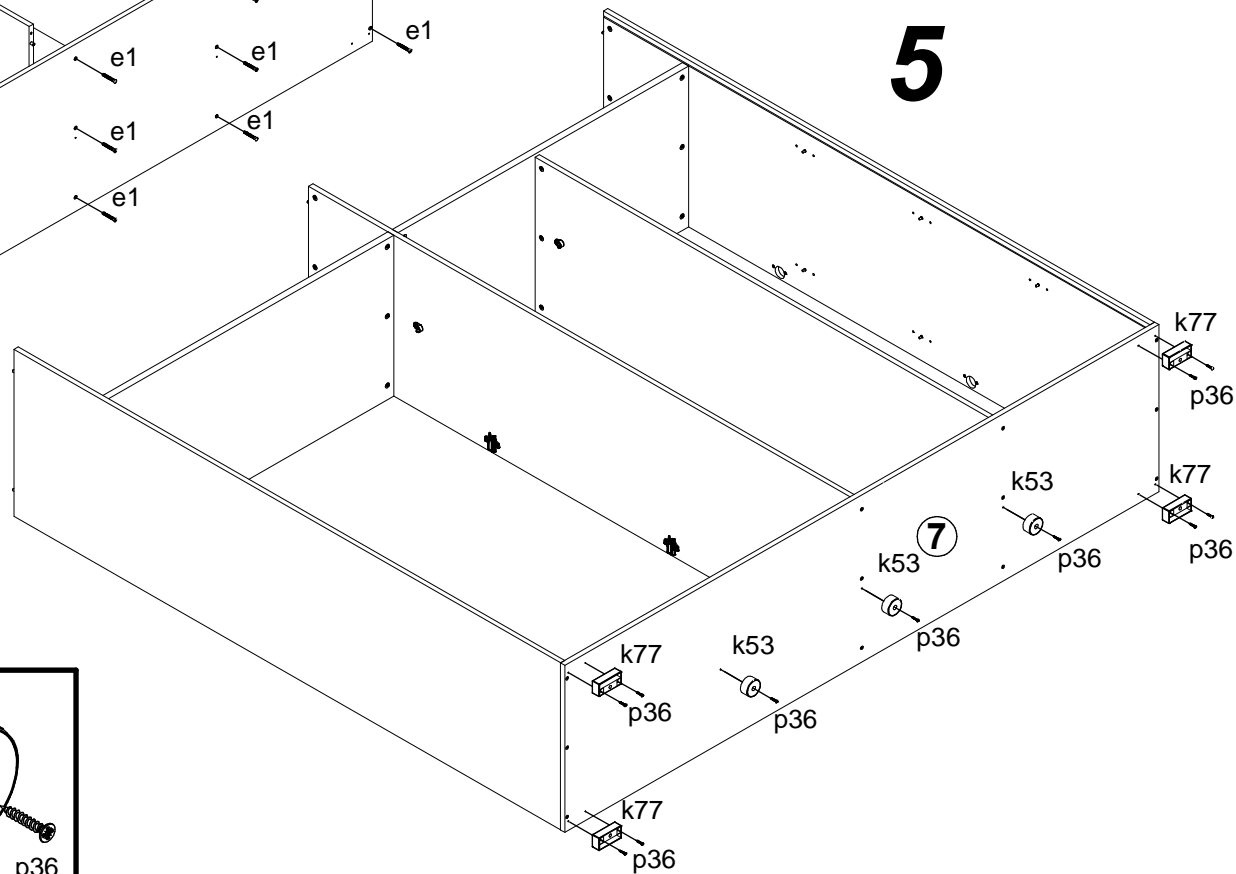

6

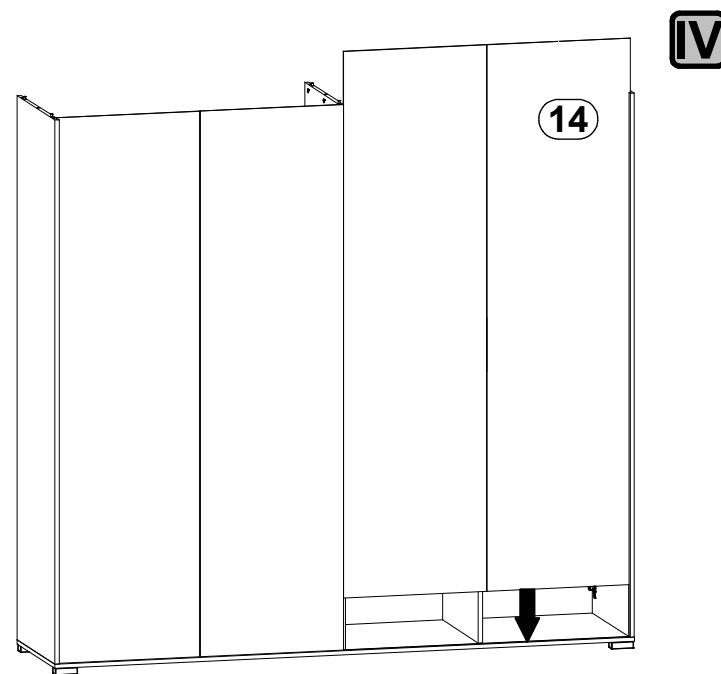
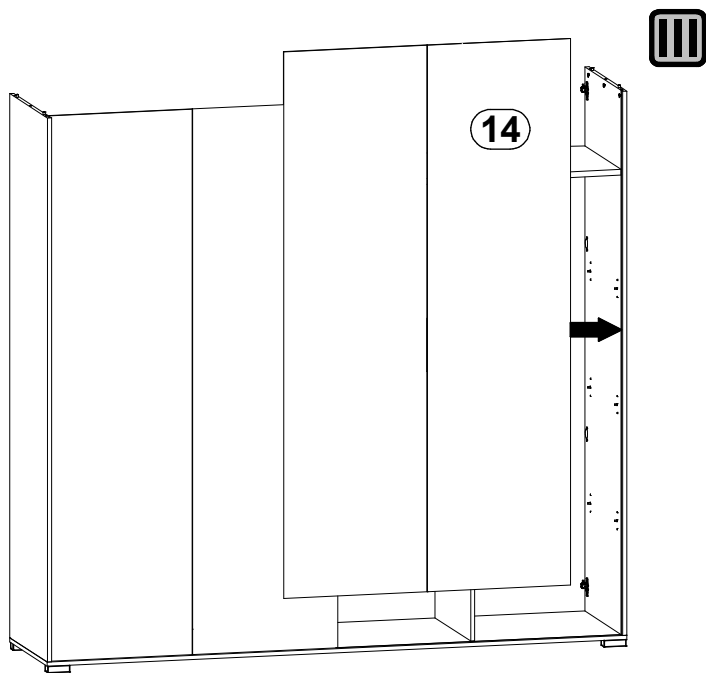
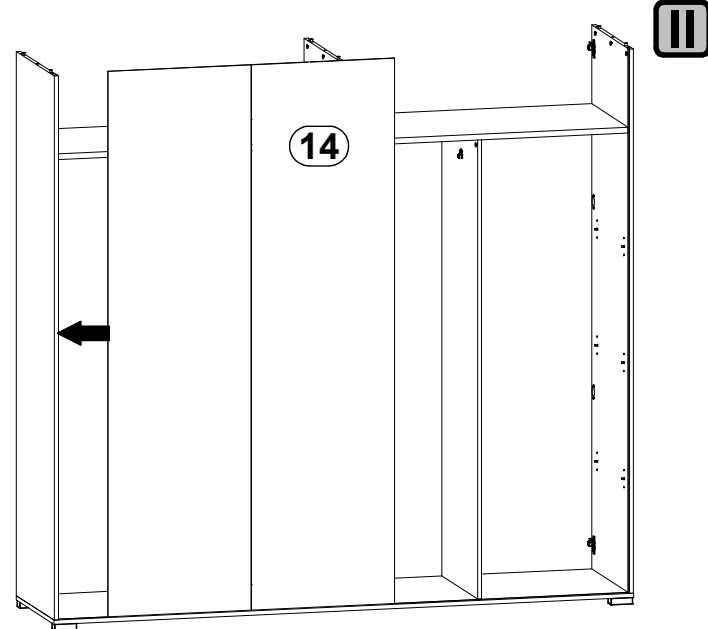
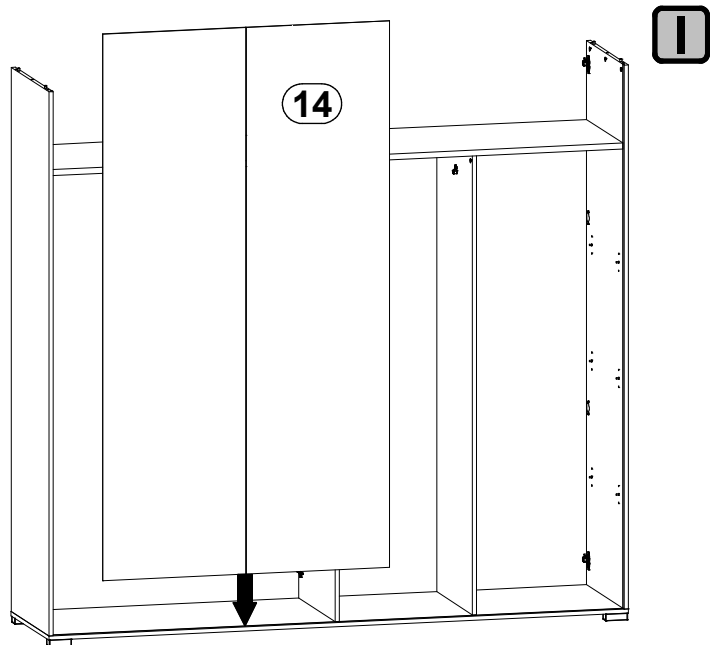



7

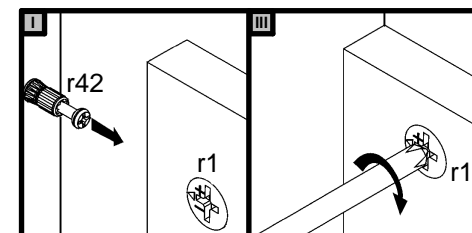
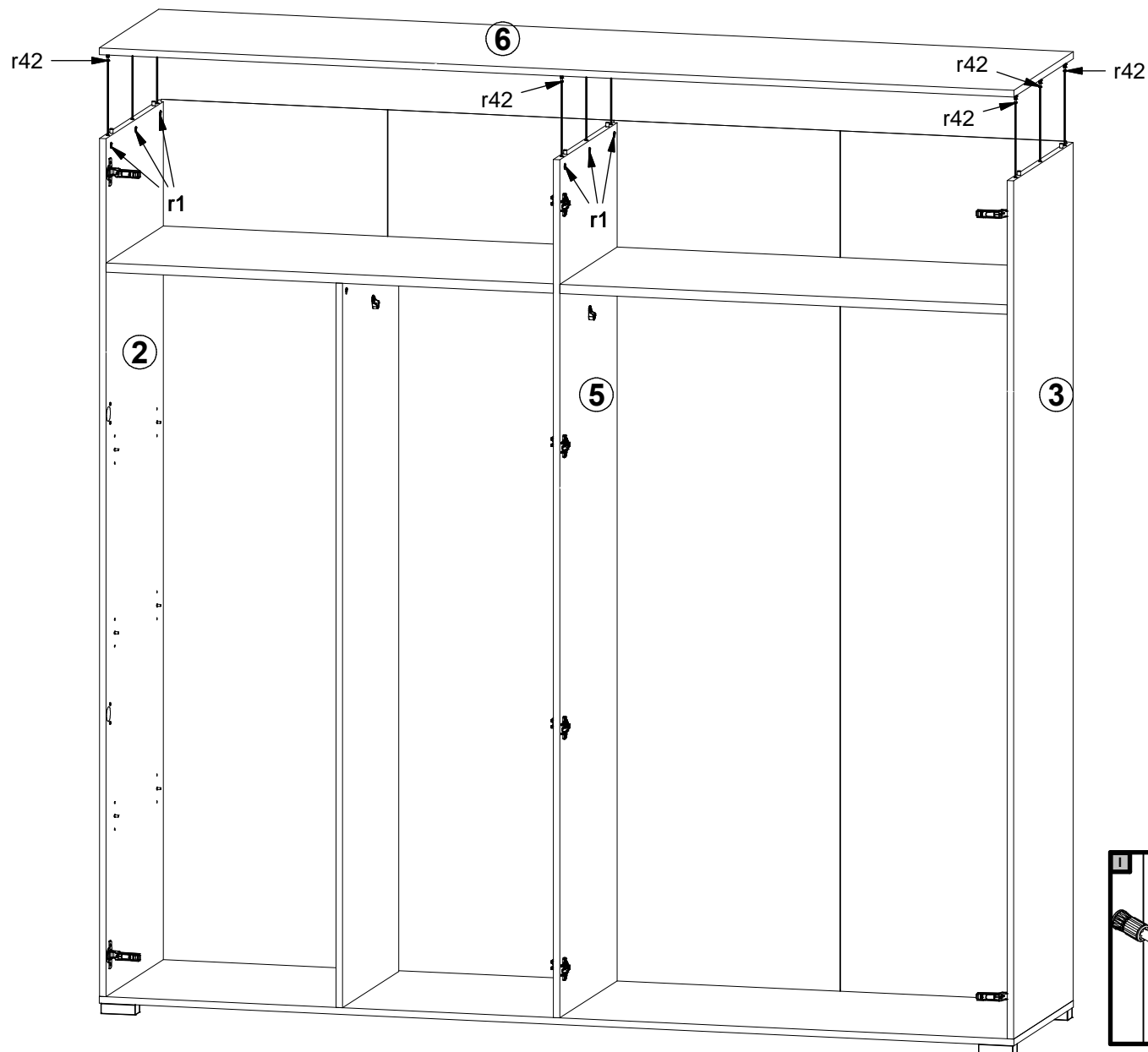

8

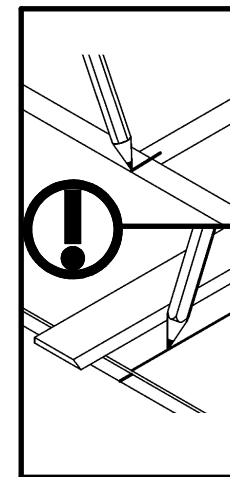
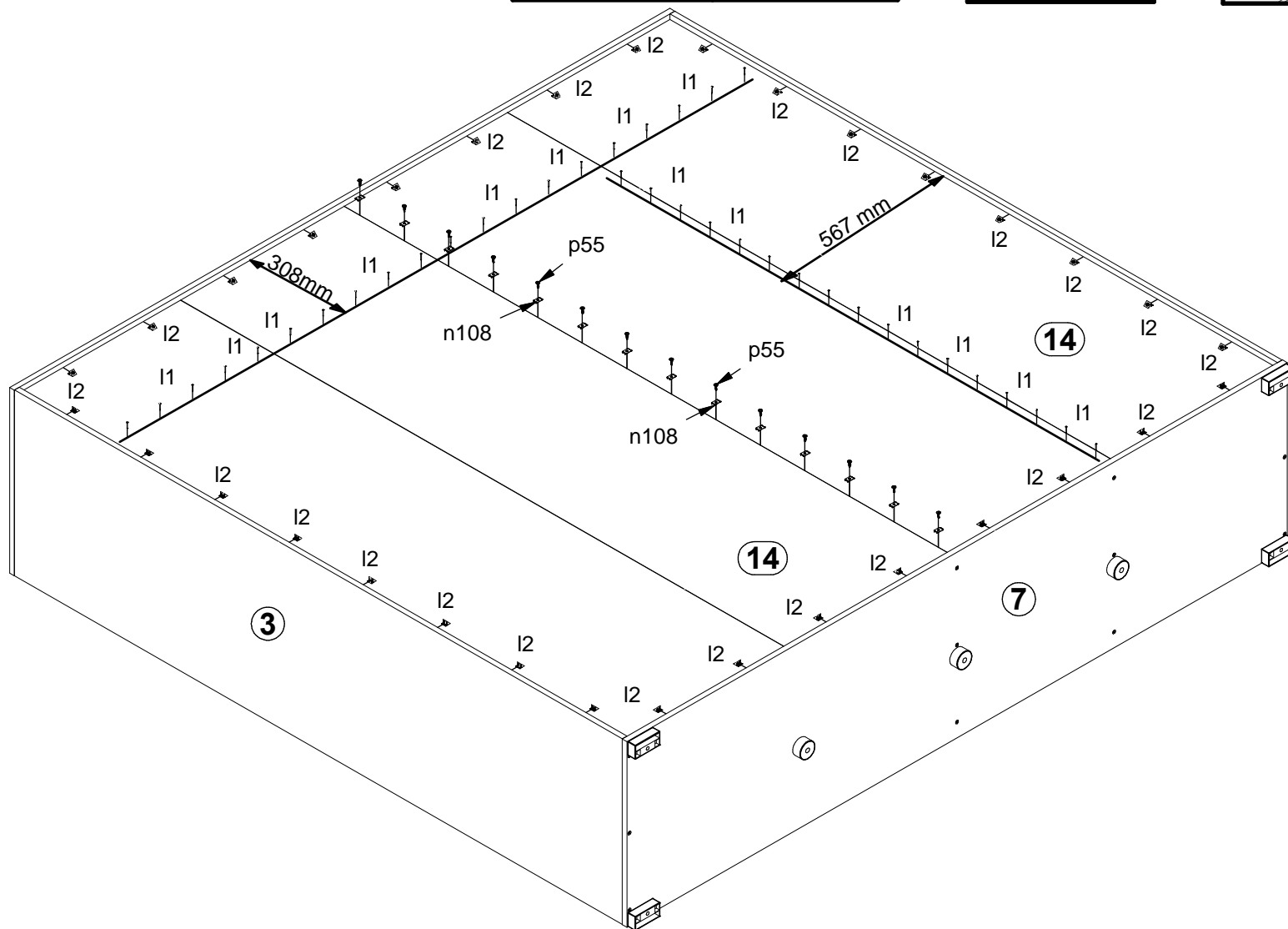
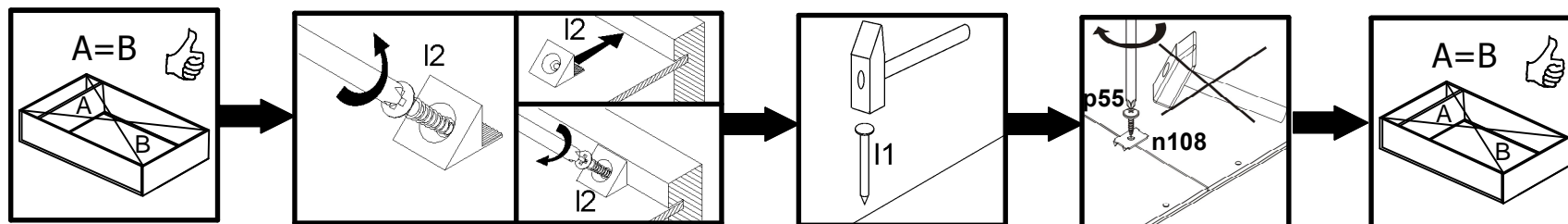

9

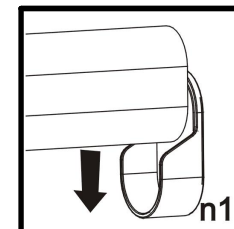
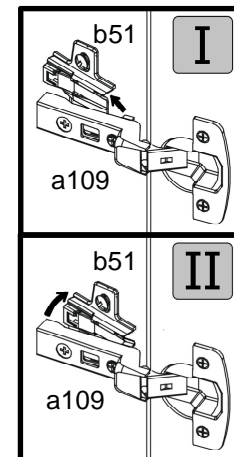
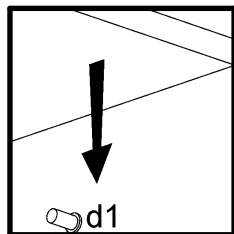
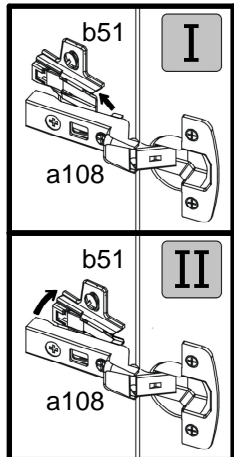
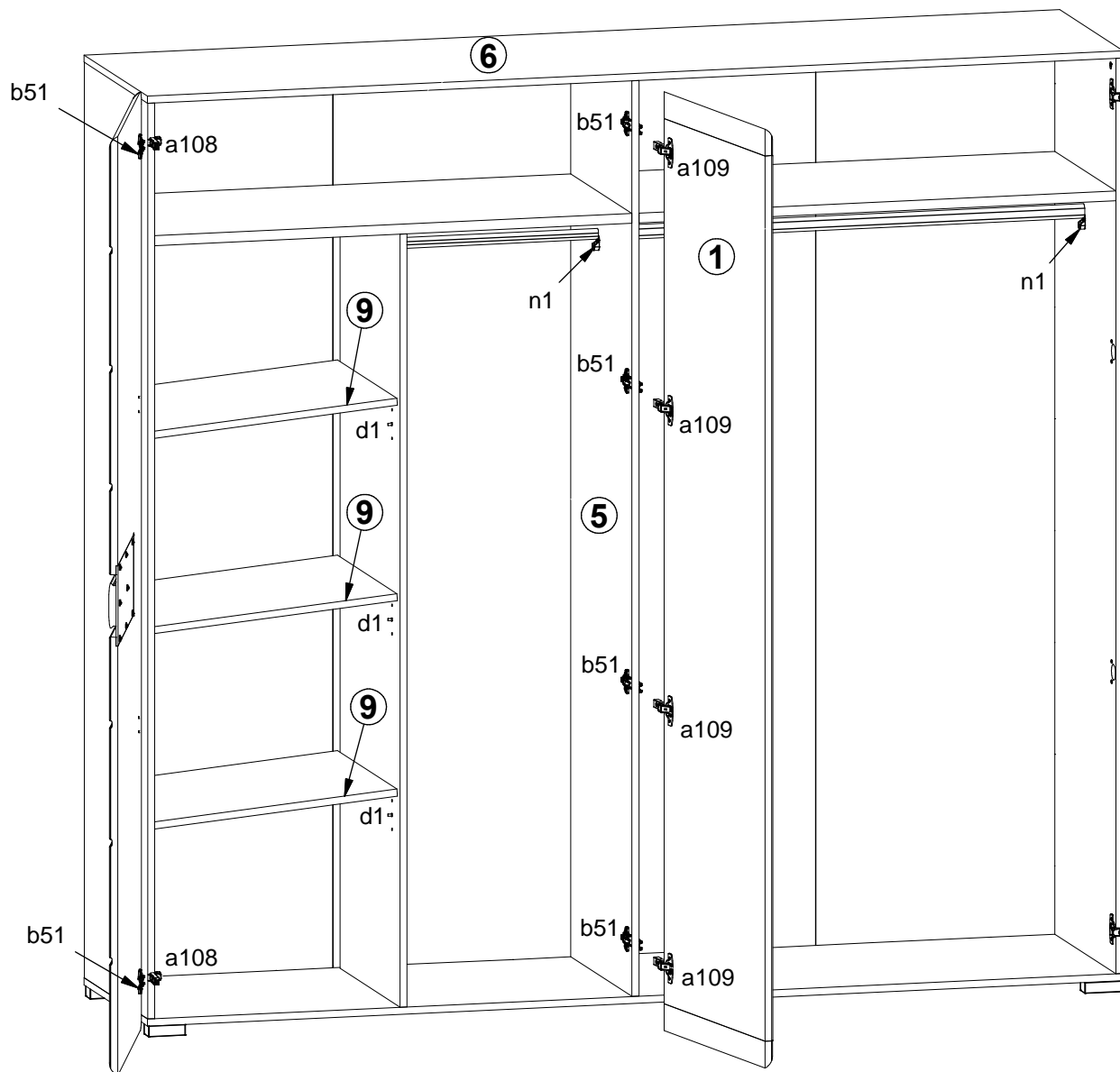

# 10

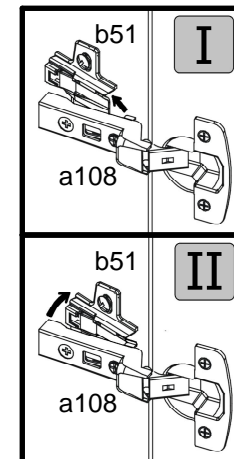
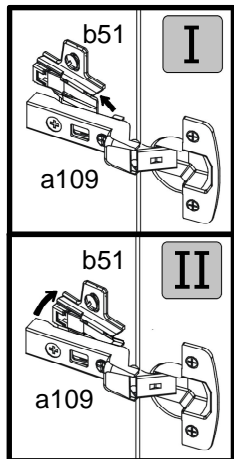
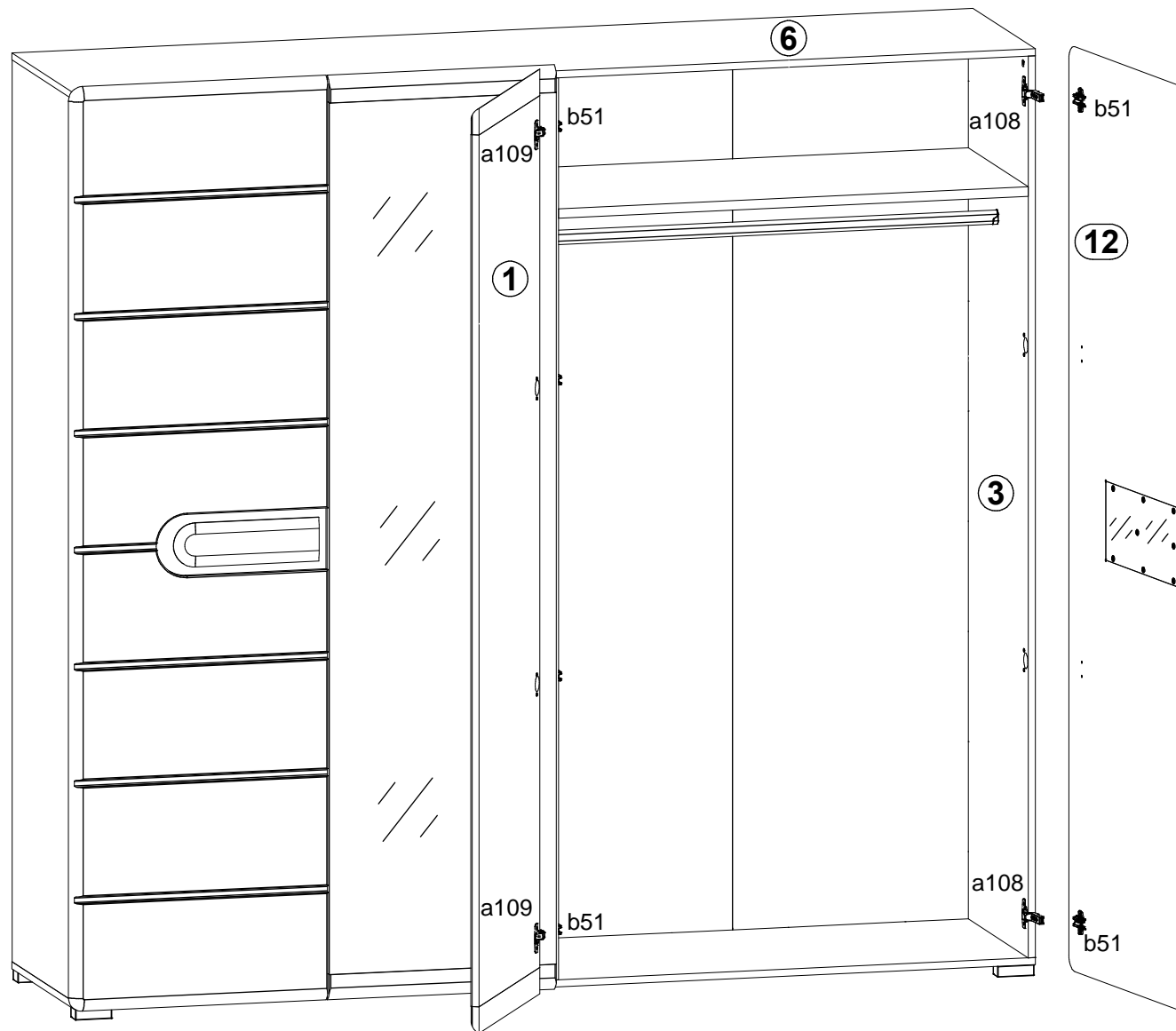

# 11

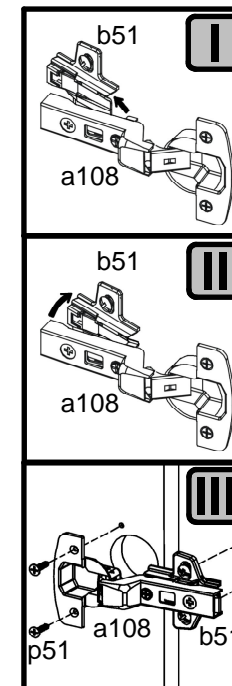
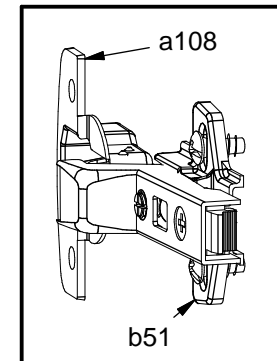
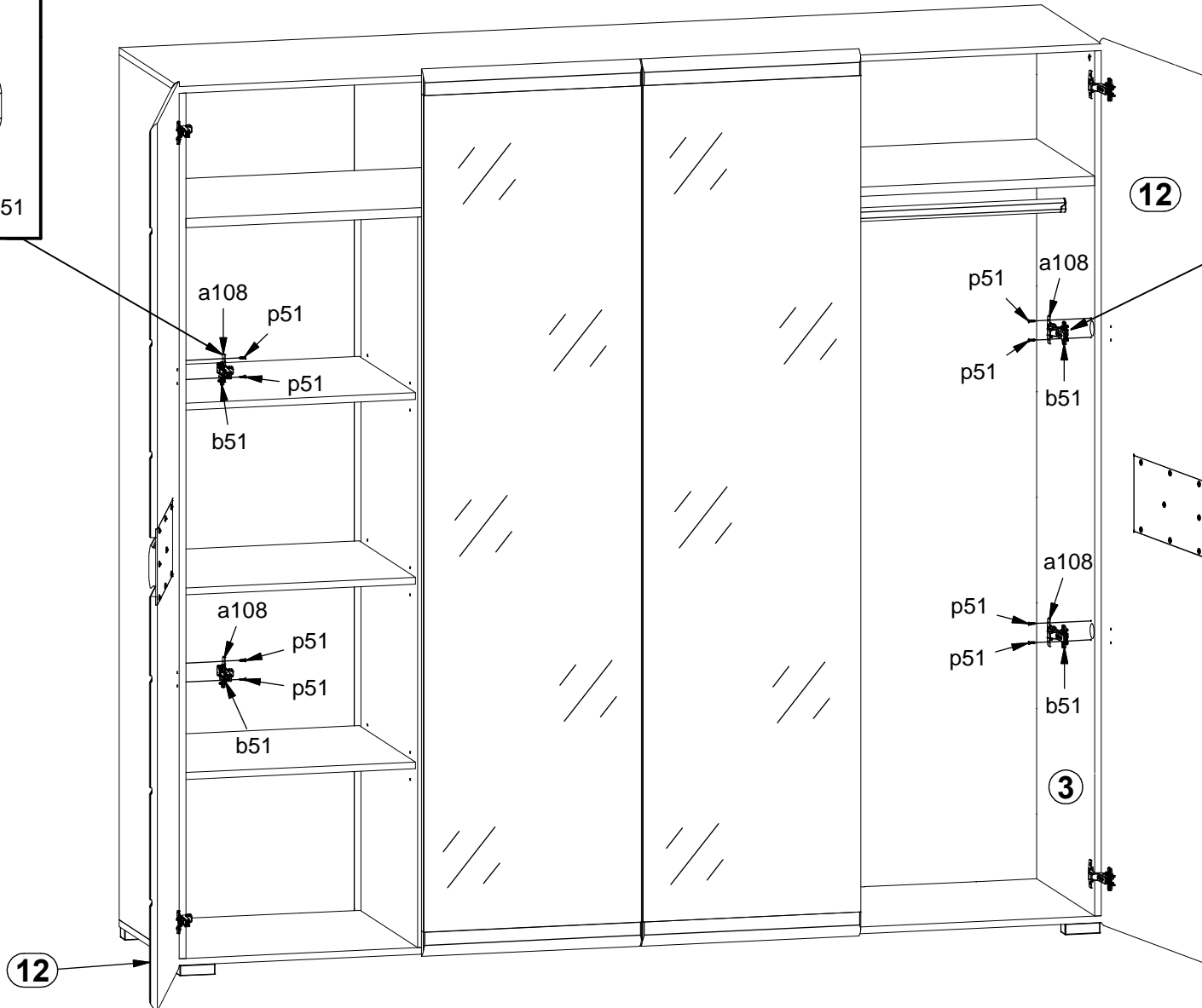
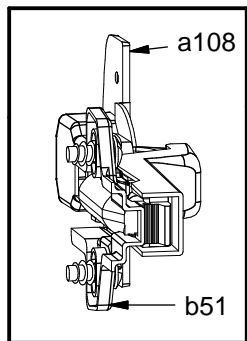

12

